

Network Digital Video Recorder

H.264

Network DVR User manual

V2.1

Please read instructions thoroughly before operation and retain it for future reference.ENG

Welcome

Thank you for purchasing our DVR!

This manual is designed to be a reference tool for the installation and operation of your system.

Here you can find information about this series DVR features and functions, as well as a detailed menu tree.

Before installation and operation please read the following safeguards and warnings carefully!

Important Safeguards and Warnings

Do not place the heavy object on the DVR.

Do not let any solid or liquid fall into or infiltrate the DVR.

Please brushing the printed circuit boards, connectors, fans, machine box and so on regularly. Before the dust cleaning please switch off the power supply and unplug it.

Do not disassemble or repair the DVR by yourself. Do not replace the electronic components by yourself.

Environment

Please place and use the DVR between 0°C and 40°C. Avoid direct sunlight. Stay away from heat source.

Do not install the DVR in damp environment.

Do not use the DVR in smoky or dusty environment.

Avoid collision or strong fall.

Please insure the DVR level installation in a stable workplace.

Please install in ventilated place. Keep the vent clean.

Use within the rating input and output scope.

Contents

1. Production Introduction	4
1.1 Product overview	4
1.2 Main functions	4
2. Open-package check and cable connection.....	5
2.1 Open-package check	5
2.2 Frame installation.....	6
2.3 Front panel	6
2.4 Rear panel	9
2.5 Installation connections sketch map (Below just as the 4CH DVR for example,Specifically please refer to practical product.)	11
2.6 Audio and video input and output connections	11
2.6.1 Video input connections.....	11
2.6.2 Video output connections and options	12
2.6.3 Audio input.....	12
2.6.4 Audio output.....	12
2.7 Alarm input and output connections(Some models no such function,please prevail in kind.).....	13
2.7.1 Alarm input port specification(This feature should be used in conjunction and external alarm module, some models have an external alarm module for optional.)	14
2.7.2 Alarm output port specification(This feature should be used in conjunction and external alarm module, some models have an external alarm module for optional.)	14
2.8 Speed dome connections.....	15
3. Basic operation.....	15
3.1 Turn on.....	15
3.2 Turn off	15
3.3 Login.....	16
3.4 Preview	17
3.5 Desktop shortcut menu.....	17
3.5.1 Record Mode.....	17
3.5.2 Video playback.....	18
3.5.3 PTZ control	21
3.5.4 Color Setting	26
3.5.5 Output Adjust	26
3.5.6 Window switch.....	27
3.5.7 System information.....	27
3.5.7.1 Hard Disk information	27
3.5.7.2 Log information	28
3.5.7.3 Code stream statistics.....	28
3.5.7.4 Online user	29
3.5.7.5 Edition information	29
3.5.8 Logout.....	30
4. Main Menu.....	31
4.1 Main Menu navigation.....	31
4.2 Record Mode.....	32
4.3 Record Config.....	33

4.4 Encode setup	34
4.5 HDD manage	35
4.6 Network setup	36
4.7 PTZ config	43
4.8 Alarm setup	43
4.8.1 Motion Detect	43
4.8.2 Video Blind	46
4.8.3 Video Loss	46
4.8.4 Alarm input	47
4.8.5 Alarm output	47
4.9 System setup	48
4.9.1 General setup	48
4.9.2 GUI Display	49
4.9.3 Account management	51
4.9.4 Upgrade	54
4.9.5 Restore config	54
4.9.6 Backup	55
4.9.7 Device Info	56
4.9.8 AutoMaintain	56
5. Netview and Management	57
5.1 WEB network control	57
5.2 Client CMS software operation	59
6. FAQ and Maintenance	62
6.1 FAQ	62
6.2 Maintenance	67
Appendix 1.Remote controller operation	68
Appendix 2.Mouse operation	68
Appendix 3.Hard Disk capability calculation	70
Appendix 4. Technique parameters	70

1. Production Introduction

1.1 Product overview

The series DVR is designed specially for security and defence field which is an outstanding digital surveillance product. It introduces embedded LINUX operating system which is more stable. It introduces standard H.264mp video compressed format and G.711A audio compressed format which insures the high quality image, low error coding ratio and single frame playing. It introduces TCP/IP network technology which achieves the strong network communication ability and telecommunication ability.

The series DVR can be used individually or online applied as a part of a safety surveillance network. With the professional network video surveillance software it achieves the strong network communication ability and telecommunication ability.

The series DVR can be applied in the bank, telecom, electric power system, judicial system, transportation, intelligent housing, factory, storehouse, water conservancy and so on.

1.2 Main functions

Real-time surveillance

- analog interface and VGA interface (VGA interface is equipped selectively)
- surveillance function through monitor or display

Storage

- non-working hard disk dormancy processing which is convenient to radiate heat, reduce power and extend the life-span
- special storage format which insures the data safety

Compression

- real-time compression by individual hard disk which insures the audio and video signal stable synchronization

Backup

- through SATA interface and USB interface such as USB equipment, removable hard disk and so on
- through net download the files in the hard disk

Playback

- individual real-time video recording as well as searching, playback, network surveillance, recording check,

downloading and so on

- multi-channel playback mode
- zoom at arbitrary region

Net operating

- through net tele-surveillance in the real time
- remote control PTZ
- remote check the recording and real-time playback

Alarm linkage

- only one channel relay alarm output which is convenient for the alarm linkage and light control at the spot
- protecting circuits at the alarm input and output interface which protects the main machine from damage

Communication interface

- RS485 interface which fulfills the alarm input and PTZ control
- standard ethernet network interface which fulfills the telecommuting function

Intelligent operating

- mouse action function
- fast copy and paste operating for the same setting

2. Open-package check and cable connection

2.1 Open-package check

When you receive the DVR, please check first .

First, please check whether there is any visible damage to the package appearance. The protective materials used for the package of the DVR can protect most accidental clashes during transportation.

Then, please open the box and get rid off the plastic protective materials. Check whether there is any visible damage to the DVR appearance.

At last, please open the machine crust and check the data wire in the front panel, power wire, the connection between the fan power and the main board.

(1).Front panel and rear panel

- ◆ The key function specification in the front panel and the interface specification in the rear panel are in the specification.
- ◆ Please check the product type in the front panel whether is accordant with the product type you order.

The label in the real panel is very important for the after service. Please protect it carefully. When you contact us for after service, please provide the product type and serial number in the label.

(2). After open the case should be checked

In addition to checking whether there are obvious signs of external damage, please note that before the inspection panel data lines, power lines and motherboard connection is loose.

2.2 Frame installation

The specification of machine box is standard 1U.It can be installed in the standard frame.

Installation approach and notice:

- 1、Mare sure the house temperature under 35°C (95°F).
- 2、Keep the DVR away from other equipments at least 15 centimeters(6 inches).
- 3、Frame installation from bottom to top.
- 4、If installing multiple components in the frame, take precaution to avoid the overload of the jack.

2.3 Front panel

4CH DVR panel 1:

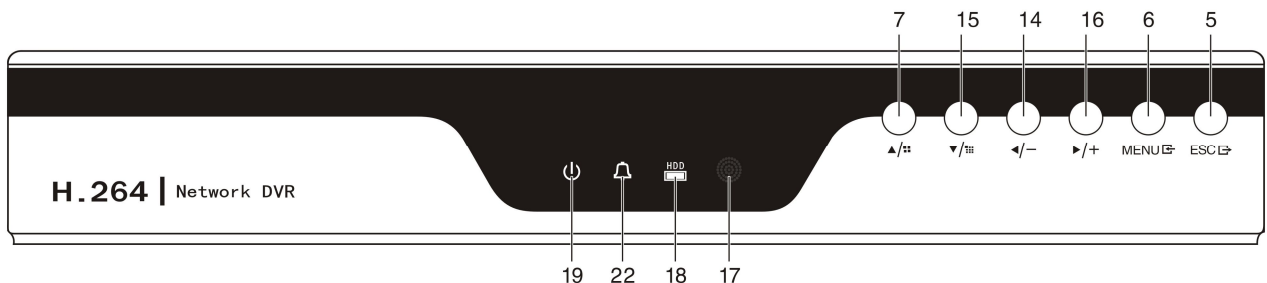

4CH DVR panel 2:

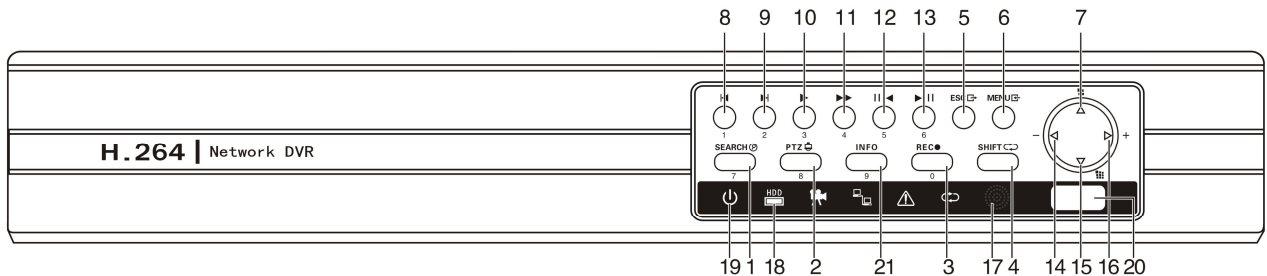

4CH DVR panel 3:

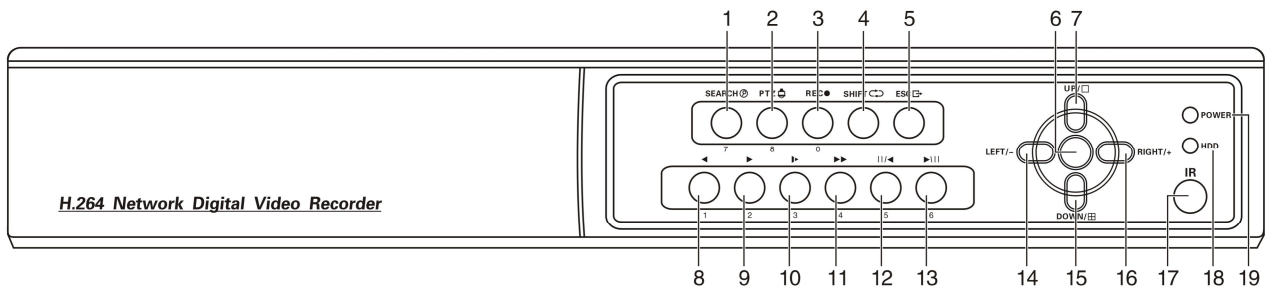

8CH DVR panel 1:

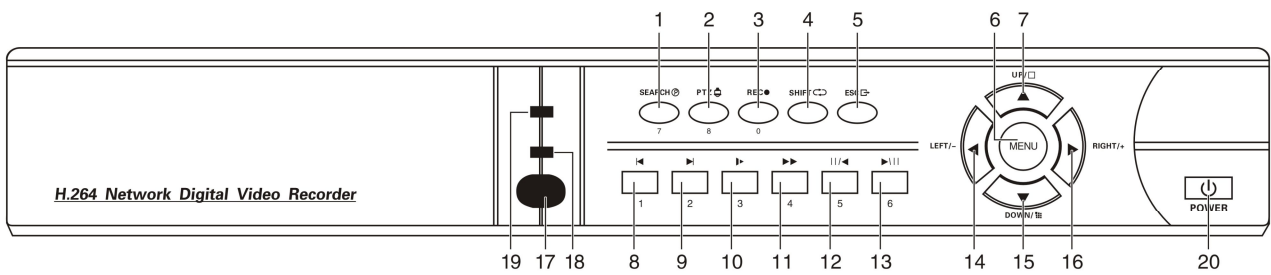

8CH DVR panel 2:

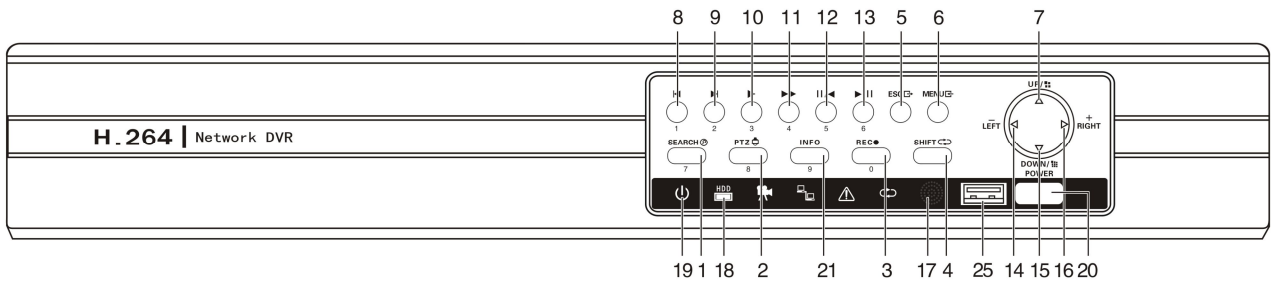

16CH DVR panel / 24CH DVR panel / 32CH DVR panel

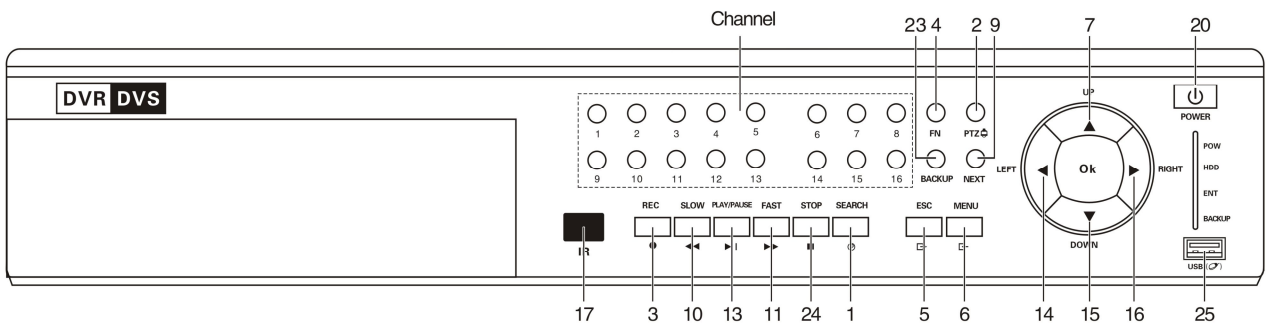

- (1) recording search button / 7
- (2) PTZ control button / 8
- (3) recording button / 0
- (4) shift function button
- (5) cancel button
- (6) menu & confirm button

- (7) Up button
- (8) Play previous file / 1
- (9) Play next file / 2
- (10) Slow play / 3
- (11)Fast play / 4
- (12) Playback or pause / 5
- (13) Play or pause / 6
- (14) Left button
- (15) Down button
- (16) Right button
- (17) IR remoter receiver
- (18) Hard disk indicator light
- (19) Power indicator light
- (20)Power switch
- (21)Hard disk information
- (22)Alarm
- (23)Backup
- (24) Stop
- (25) USB interface

Front panel button operation function table

Num.	Button name	Mark	Function
1	Shift function button	SHIFT	Shift in the number button, character button and other function button during the user under input state
2	Direction button	∨ ^	Remove the cursor
			Add or decrease number during the user edit state
			Change the setting in the menu
			Enter 1 channel or 4 channels surveillance during surveillance image
			After pressing the shift button, press this button can enter 1 or 4 during edit state
		< >	Remove the cursor when the main menu or submenu is popped
			Remove the cursor during the playback state
			Enter 2 channel or 3 channel surveillance during surveillance image
	Main menu/Confirm button	ENTER	Confirm
			Enter main menu
3	Cancel button	ESC	Back to the above level menu or cancel operation in the operation menu
			Back to the real-time surveillance during the playback state
4	Play previous file button	⏮	Play previous video during the playback state Enter 1 during edit state
5	Play next file button	⏭	Play next video during the playback state Enter 2 during edit state
6	Slow play	▶	Play in the multi-low or regular speed video during the playback state Enter 3 during edit state
7	Fast play	▶▶	Play in the multi-fast or regular speed video during the playback state Enter 4 during edit state
8	Playback/pause button	⏮/⏪	Playback the video or pause during the playback state

			Enter 5 during edit state
9	Play/pause button	▶	Play the video or pause during the playback state Enter 6 during edit state
10	Recording button	REC	Start/stop the video recording manually With the direction button choose the channel in the recording control menu

2.4 Rear panel

4CH DVR panel 1

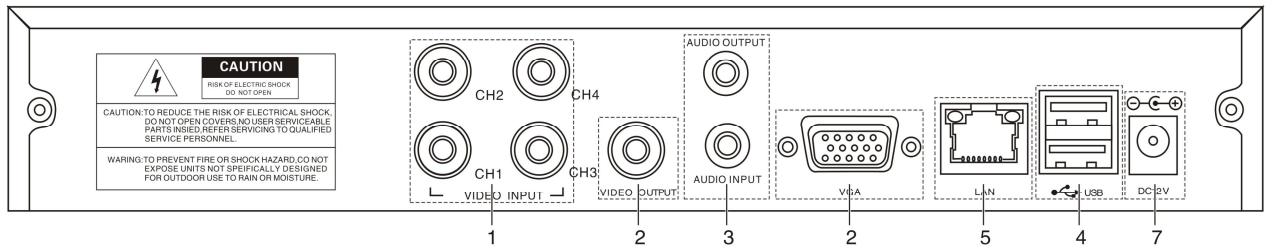

4CH DVR panel 2

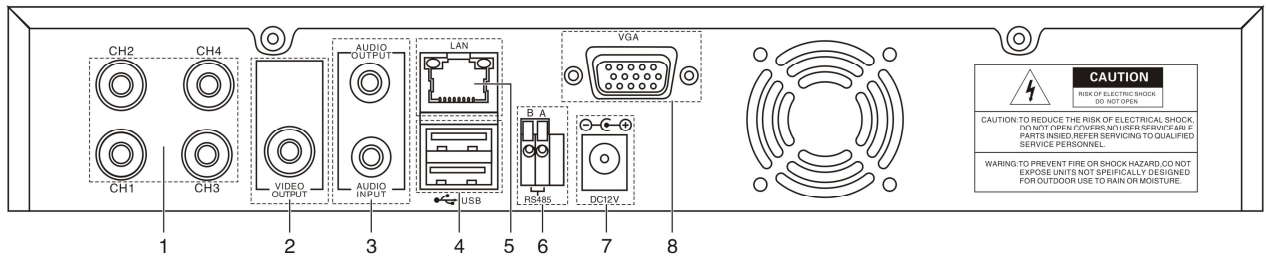

4CH DVR panel 3

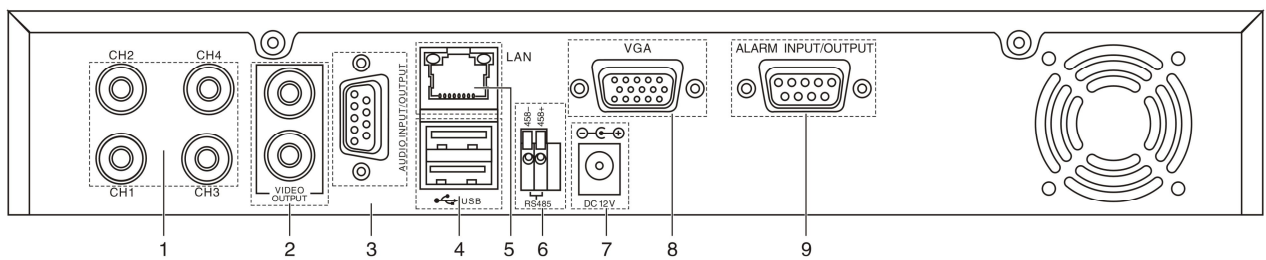

8CH DVR panel

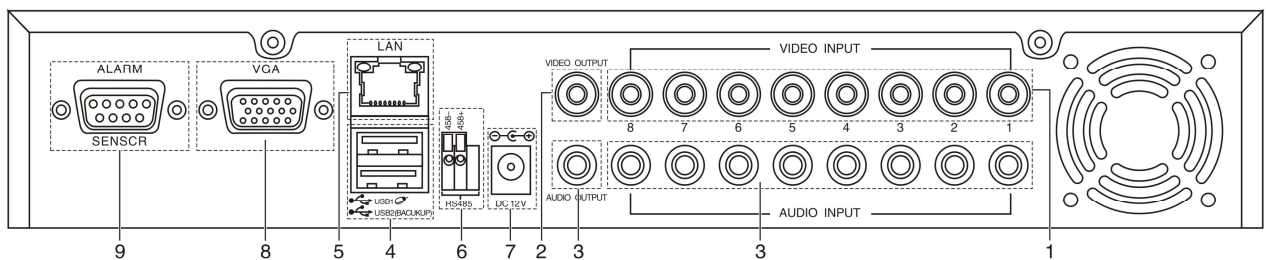

16CH DVR panel

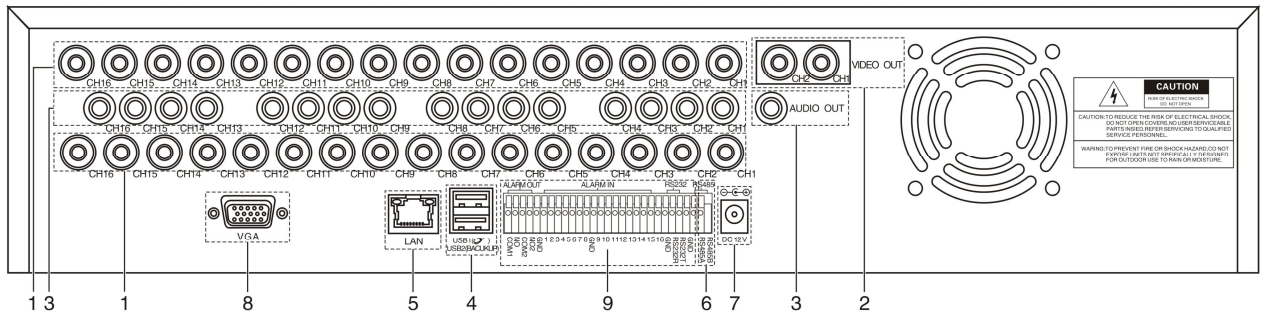

24CH DVR panel

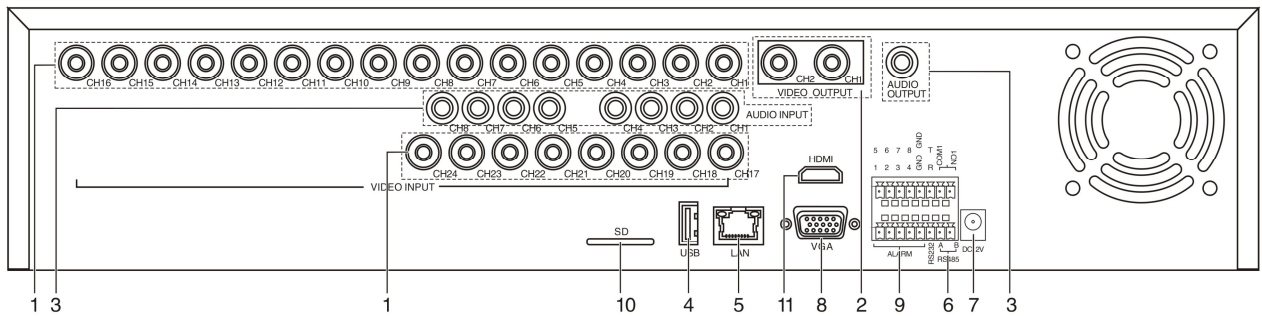

32CH DVR panel

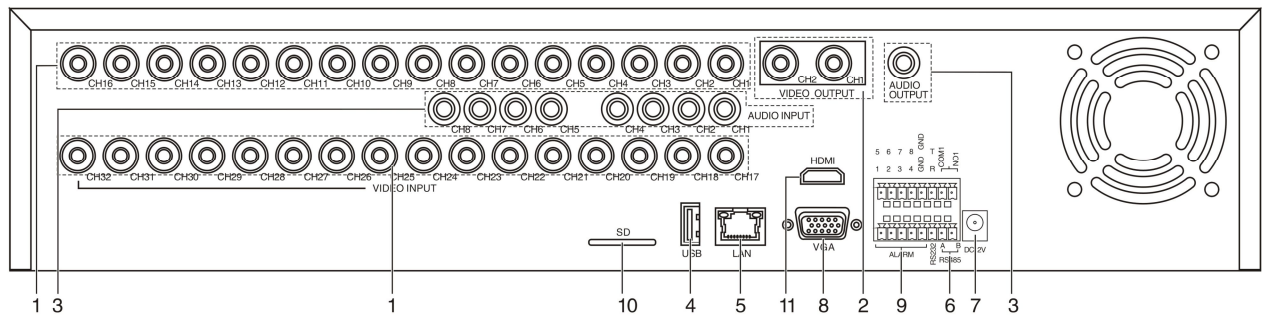

- | | | |
|------------------------|-----------------------|-------------------------------|
| (1) Video input | (2) Video output | (3) Audio input/ audio output |
| (4) USB interface | (5) Network interface | (6) RS-485 interface video |
| (7) Power jack | (8) VGA output | (9) Alarm input/alarm output |
| (10) SD Card interface | (11) HDMI interface | |

Note: Some models have front panel USB interface, this interface with the top of the rear panel USB port are mutually exclusive, only one interface at the same time effective. The bottom of a rear panel USB as an independent and effective.

2.5 Installation connections sketch map (Below just as the 4CH DVR for example,Specifically please refer to practical product.)



2.6 Audio and video input and output connections

2.6.1 Video input connections

The video input port is BNC connector plug. The demand of input signal is PAL/NTSC BNC(1.0V_{p-p},75Ω).

The video signal must be accorded with the state standard which has the high signal to noise ratio, low aberration and low interference. The image must be clear and has natural color in the appropriate brightness.

Insure the camera signal stable and credible

The camera should be installed in the appropriate location where is away from backlighting and low illumination or adopts the better backlighting and low illumination compensation.

The ground and power supply of the camera and the DVR should be shared and stable.

Insure the transmission line stable and credible

The video transmission line should adopt high quality coaxial pair which is chosen by the transmission distance. If the transmission distance is too far, it should adopt shielded twisted pair, video compensation

equipment and transmit by fiber to insure the signal quality.

The video signal line should be away from the electro magnetic Interference and other equipments signal lines. The high voltage current should be avoided especially.

Insure the connection stable and credible

The signal and shield lines should be firm and connected credible which avoid false and joint welding and oxidation.

2.6.2 Video output connections and options

The video output is divided into PAL/NTSC BNC($1.0V_{P-P}$, 75Ω) and VGA output(selective configuration).

When replace the monitor by the computer display, there are some issues to notice.

- 1、 Do not stay in the turn-on state for a long time.
- 2、 Keep the computer display normal working by demagnetizing regularly.
- 3、 Stay away from the electro magnetic Interference.

TV is not a credible replacement as a video output. It demands reducing the use time and control the power supply and the interference introduced by the nearby equipments strictly. The creepage of low quality TV can lead to the damage of other equipments.

2.6.3 Audio input

Audio port is RCA connection.

The input impedance is high so the tone arm must be active.

The audio signal line should be firm and away from the electro magnetic Interference and connected credible which avoid false and joint welding and oxidation. The high voltage current should be avoided especially.

2.6.4 Audio output

Commonly the output parameter of DVR audio signal is greater than $200mv$ $1K\Omega$ (BNC) which can connect the low impedance earphone and active sound box or other audio output equipments through power amplifier. If the sound box and the tone arm can not be isolated, howling phenomena is often existed. There are some methods to deal with the above phenomena.

- 1、 Adopt better directional tone arm.
- 2、 Adjust the sound box volume to be under the threshold that produces the howling phenomena.

- 3、 Use fitment materials that absorb the sound to reduce reflection of the sound.
- 4、 Adjust the layout of the sound box and the tone arm.

2.7 Alarm input and output connections(Some models no such function,please prevail in kind.)

1 、 Alarm input

- A. Alarm input is grounding alarm input.
- B. Alarm input demand is the grounding voltage signal.
- C. When the alarm is connected with two DVRs or connected with DVR and other equipments, it should be isolated by relay.

2 、 Alarm output

Alarm output can not be connected with high-power load(no more than 1A).When forming the output loop it must prevent the big current from relay damage. Use the contact isolator when there is a high-power load

3 、 PTZ decoder connections

- A. The grounding of the PTZ decoder and DVR must be shared otherwise the common-mode voltage will lead to the PTZ control failure. The shielded twisted pair is recommended.
- B. Avoid the entrance of high voltage. Make the layout reasonably. Take precaution from the thunder.
- C. In the outlying end connect 120Ω resistance paralleled to reduce the inflection and insure the signal quality.
- D. The RS485 +、 - lines of DVR can not connected with other RS485 output equipments paralleled.
- E. The voltage between the +、 - lines of the decoder must be less than 5V.

4、 Front equipment grounding note

Bad grounding can lead to the burnout of the chip.

5、 Alarm input type unlimited

The DVR alarm output port is constant opening type.

ALARM INPUT/OUTPUT

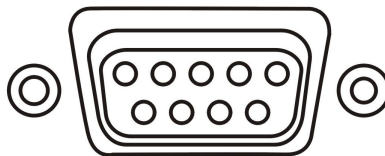

2.7.1 Alarm input port specification (This feature should be used in conjunction and external alarm module, some models have an external alarm module for optional.)

4 channels alarm input. Alarm input type unlimited.

The grounding and the com port of the alarm sensor are parallel (The alarm sensor is external power supply) .

The grounding of the alarm and the DVR should be shared.

The NC port of the alarm sensor must be connected with the DVR alarm input port.

The grounding of the power supply and the alarm sensor must be shared when used in external power supply.

2.7.2 Alarm output port specification (This feature should be used in conjunction and external alarm module, some models have an external alarm module for optional.)

1 channels alarm output. There is external power supply when using the external alarm equipment.

To avoid overload and damage the system, please refer to the relay before the connection, the relay parameters related to the Annex.

2.7.3 Alarm output port relay parameters

Type: JRC-27F		
Interface material	silver	
rating (resistance load)	Rating switch capacity	30VDC 2A, 125VAC 1A
	maximal switch power	125VA 160W
	maximal switch voltage	250VAC, 220VDC
	maximal switch current	1A
isolation	Homo-polarity interface	1000VAC 1minute
	Inhomo-polarity interface	1000VAC 1 minute
	Interface and winding	1000VAC 1 minute
Surge voltage	Homo-polarity interface	1500VAC (10×160us)
Turn-on time	3ms max	
Turn-off time	3ms max	
longevity	mechanical	50×106 MIN (3Hz)
	electric	200×103 MIN (0.5Hz)
Environment temperature	-40~+70℃	

2.8 Speed dome connections

- 1、 Connect the 485 lines of the speed dome with the DVR 485 interface.

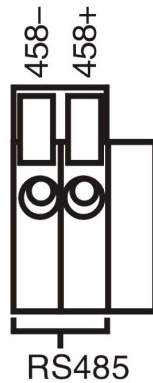

- 2、 Connect the video line with the DVR video input.
- 3、 Electrify the speed dome.

3. Basic operation

3.1 Turn on

Plug the power supply and turn on the power supply switch. Power supply indicator light shining indicates turning on the video recorder. After the startup you will hear a beep. The default setting of video output is multiple-window output mode. If the startup time is within the video setting time, the timing video recording function will start up automatically. Then the video indicator light of corresponding channel is shining and the DVR is working normally.

Note:1. Make sure that the input voltage corresponds with the switch of the DVR power supply.

2. Power supply demands: 220V±10% /50Hz-60Hz.

Suggest using the UPS to protect the power supply under allowable conditions.

3.2 Turn off

There are two methods to turn off the DVR. Soft-switching: Entering [right menu] and choosing [turn off] in the [turn off the system] option; Hard-switching: Press the power button on the front panel or rear panel power switch can switch power.

Notice:

- 1、 Auto resume after power failure

If the DVR is shut down abnormally, it can automatically backup video and resume previous working status after power failure.

2、 Replace the hard disk

Before replacing the hard disk, the power supply switch in the real panel must be turned off.

3、 Replace the battery

Before replacing the battery, the setting information must be saved and the power supply switch in the real panel must be turned off. The DVR uses button battery. The system time must be checked regularly. If the time is not correct you must replace the battery, we recommend replacing the battery every year and using the same battery type.

Note: The setting information must be saved before replacing the battery otherwise information will lose.

3.3 Login

When the DVR boots up, the user must login and the system provides the corresponding functions with the user purview. There are four user settings. The names are Admin, User, Guest and Default. Admin default have no password. Default is default user name when booting up; Admin and User are the super user at the factory presetting ;Guest is the common user at the factory presetting; Default user's factory presetting permissions are preview and playback.

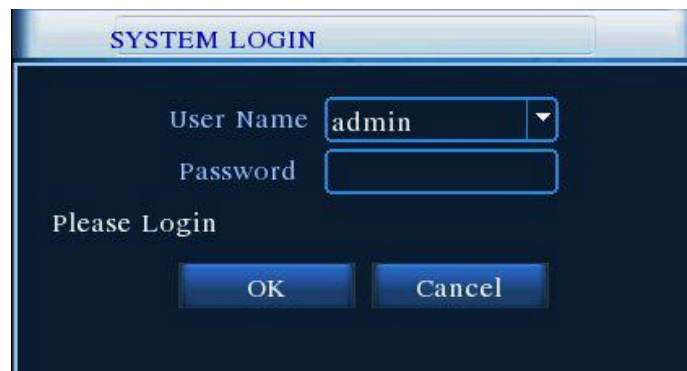

Picture3.1 Login





Password protection: If the password is continuous wrong three times, the alarm will start. If the password is continuous wrong five times, the account will be locked. (After reboot or half an hour, the account will be unlocked automatically)

For your system security, please modify your password after first login. (Chapter 4.9.3 User Management)

3.4 Preview

You can right click mouse to choose the switch between the windows.

The system date, time and channel name are shown in each viewing window. The surveillance video and the alarm status are shown in each window.

1		Recording status	3		Video loss
2		Motion detect	4		Camera lock

List 3.1 Preview icon

3.5 Desktop shortcut menu

In preview mode you can right click mouse to get a desktop shortcut menu. The menu includes: **Main Menu, Record Mode, Playback, PTZ control, Color Setting, Output Adjust, Window switch, Info and Logout.**

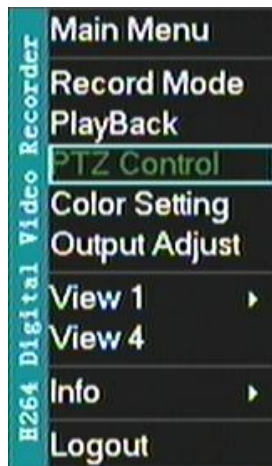

Picture 3.2 shortcut menu

3.5.1 Record Mode

Please check current channel status: “●” means it is in recording status.

You can use desktop shortcut menu or click [main menu]> [record Mode] to enter the recording control interface



Picture3.3 recording control interface

【Timing】 Record according to the configuration.

【Manual】 Click the all button and the according channel is recording no matter the channel in any state.

【Stop】 Click the stop button and the according channel stops recording no matter the channel in any state.

3.5.2 Video playback

Play the video files in the hard disk.

Note: The hard disk that saves the video files must be set as read-write or read-only state.(Please referred to Chapter 4.5 for HDD Manage)

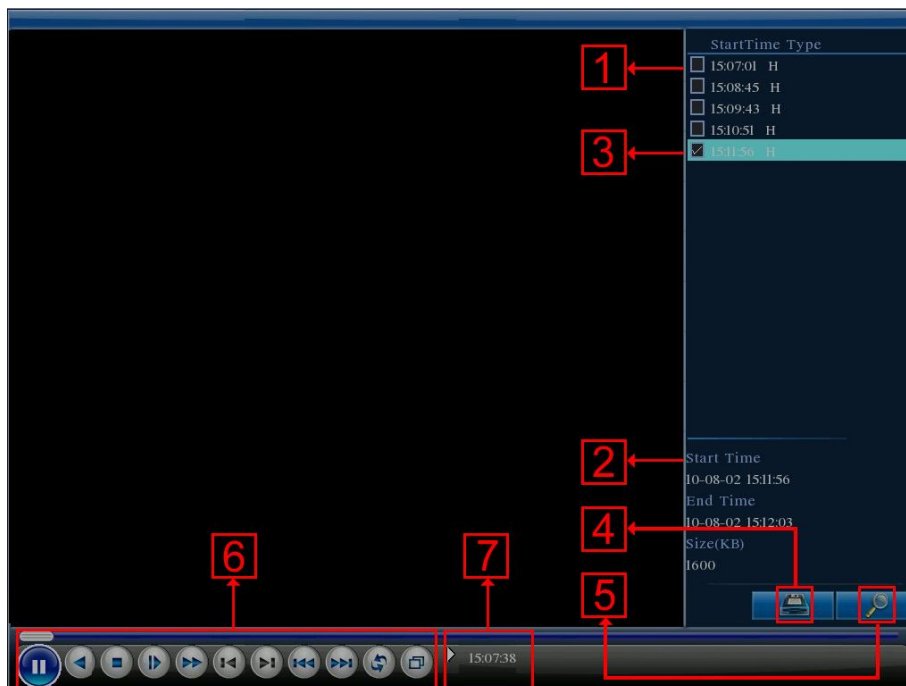

Picture3.4 Video Playback

- 1. listed files
- 2. file information
- 3. file backup option
- 4. file backup
- 5. file searching
- 6. playback control
- 7. operation hint

【listed files】 Look up the listed files that accord with the searching criteria.

【file information】 Look up the found file information.

【file backup option】 Choose the file to backup .

【file backup】 Backup the chosen file. Click the button,and Pop Picture 3.5,operate as follow instruction.

Note: Before the file backup,must be installed a enough storage device;

If the backup is terminated, the already backup can playback individually.

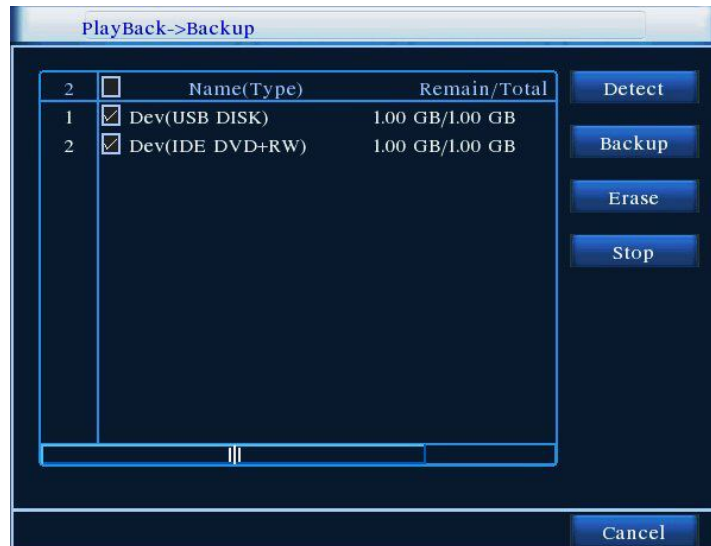

Picture 3.5 detect the storage

Detect: Detect the storage connected with the DVR such as USB hard disk or USB Flash memory disk,etc.

Erasure: Choose the file to delete and click erasure to delete the file.

Stop: Stop the backup.

Backup: Click “Backup” button and the dialog box is popped up.You can choose the backup file according to the type, channel and time.

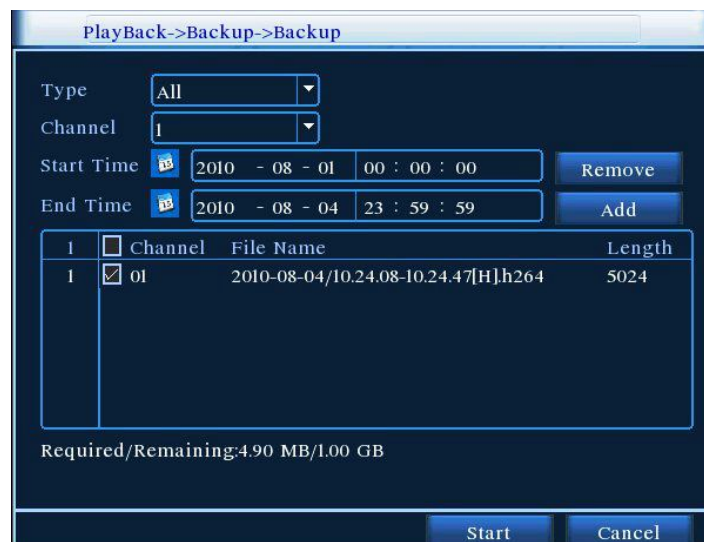

Picture 3.6 recording backup

Remove: Clear the file information.

Add: Show the file information satisfying the set file attributes.

Start/Pause: Click the play button to start the backup and click the pause button to stop the backup.

Cancel: During backup you can exit the page layout to carry out other functions.

Note: During backup, may withdraw from the page to perform other functions

【file searching】 Search the file according to the searching parameter.



Picture 3.7 file searching

File type: Select the playback file type.

Channel: Select the playback channel,also can choose other channels to simultaneously play back.

Start Time: Search video files to set the starting time.

End time: Set the video file to search the end of time.

【playback control】 Refer to the following sheet for more information.

Button	Function	Button	Function
	Play/Pause		Backward
	Stop/Close		Volume
	Slow play		Fast play
	Previous frame		Next frame
	Previous file		Next file
	Circulation		Full screen

List 3.2 Playback control key list

Note: Frame by frame playback is only performed in the pause playback state.

【operation hint】 Display the function of the cursor place.

Special Functions:

Accurate playback: Input time (h/m/s) in the time column and then click play  button. The system can operate accurate playback according to the searching time.

Local zoom: When the system is in single-window full-screen playback mode, you can drag your mouse in the screen to select a section and then left click mouse to realize local zoom. You can right click mouse to exit.

3.5.3 PTZ control



Operation interface is as followed. The functions include: PTZ direction control, step, zoom, focus, iris, setup operation, patrol between spots, trail patrol, boundary scan, assistant switch, light switch, level rotation and so on.



- Note:**
1. Decoder 485+、485- line connects with DVR 485+、485- line. The connection is right.
 2. Click [main menu] >[PTZ setup] to set the PTZ parameters.
 3. The PTZ functions are decided by the PTZ protocols.





Picture3.8 PTZ setup

【Speed】 Set the PTZ rotation range. Default range: 1 ~ 8.

【Zoom】 Click  /  button to adjust the zoom multiple of the camera.

【Focus】 Click  /  button to adjust the focus of the camera .

【Iris】 Click  /  button to adjust the iris of the camera.

【Direction control】Control the PTZ rotation. 8 directions control is supportive.(4 directions in Front panel is supportive)

【PTZ Trace】 Full-screen show channel image. Left press mouse and control PTZ to rotate orientation. Left press mouse and then rotate the mouse to adjust the zoom multiple of the camera.

【Set】 Enter the function operation menu.

【Page Switch】 Switch between different windows.

Special Functions:

1、Preset

Set a location for the preset, calls the preset points, PTZ automatically turns to the setting position

1) Preset option

Set a location for the preset, procedure is as follows:

Step1: in Picture 3.8, click the Direction button will turn into preset position,click the Settings button to enter

Picture 3.9.

Step 2: click the Preset button , then write the preset points in the input blank,

Step 3: click Set button, return the Picture 3.8 Complete setup, that is the preset points and preset position corresponds.

Remove Preset: Input preset points, click Remove button, remove the preset.



Picture 3.9 Preset Settings

2) Preset Point Calls

In Picture 3.8, click Page Shift button, enter PTZ control interface as shown in Picture 3.10. In the input blank, write the preset points, then click Preset button, PTZ turn to the corresponding preset point.

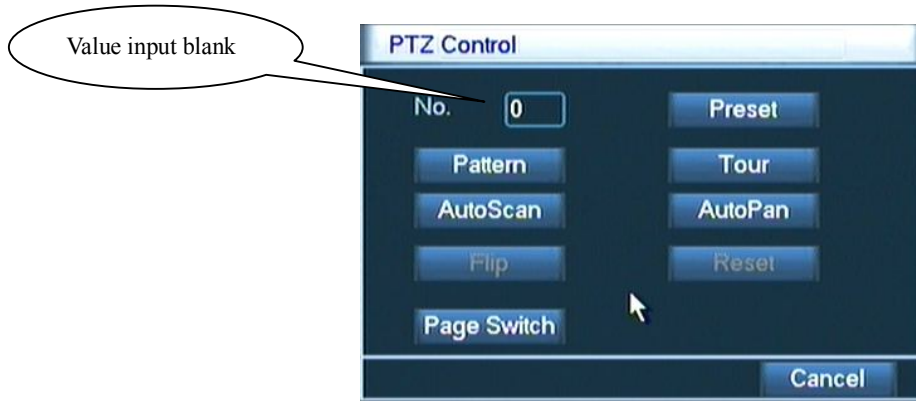

Picture 3.10 PTZ Control

2、Cruise between Points

Multiple preset points connected cruise lines, call cruise between points, the PTZ run around on the line

1) Cruise Between Points Settings

Cruise lines is connected by multiple preset points, setting procedure is as follows:

Step1: In Picture 3.8, the Direction key will turn PTZ to designated location , click Settings button to enter Picture 3.11,

Step 2: click Cruise buttons, the write proper value into the Cruise Line and Preset Points blank, then click Add Preset Points button, complete setting (also can add and delete cruise line which has been set up)

Step 3: repeat step1 and step2 , until set out all the preset designated cruise lines。

Remove Preset: Please input preset value in the blank, click Remove Preset button, then remove the preset points.

Remove Cruise Line: Input the number of cruise line, click Remove Cruise Lines button, then remove the cruise lines set.

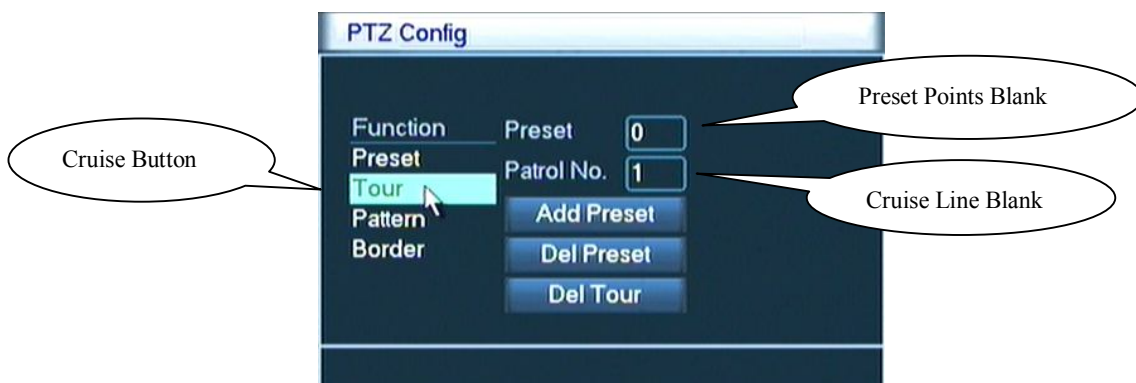

Picture 3.11 Cruise Between Points Settings

2) The Calls of Cruise between Points

In Picture 3.8, click Page Shift button, enter PTZ control menu as shown in Picture 3.10. Please input the

number of cruise in the value blank, then click Cruise between Points button, PTZ begins to work on the cruise line. Click Stop button to stop cruise.

3、Scan

PTZ also can work on the preset scan line repeatedly.

1) Scan setup

Step1: In Picture 3.8, click Setup button ,enter Picture 3.12;

Step2: Click Scan button, the input proper value in the scan value blank;

Step3: Click Start button, enter Picture 3.8, here you can set the following items: Zoom、 Focus、 Aperture、 Direction and so on. Click Setup button to go back Picture 3.12;

Step4: Click End button to complete setup。 Click the right button of the mouse to exit.

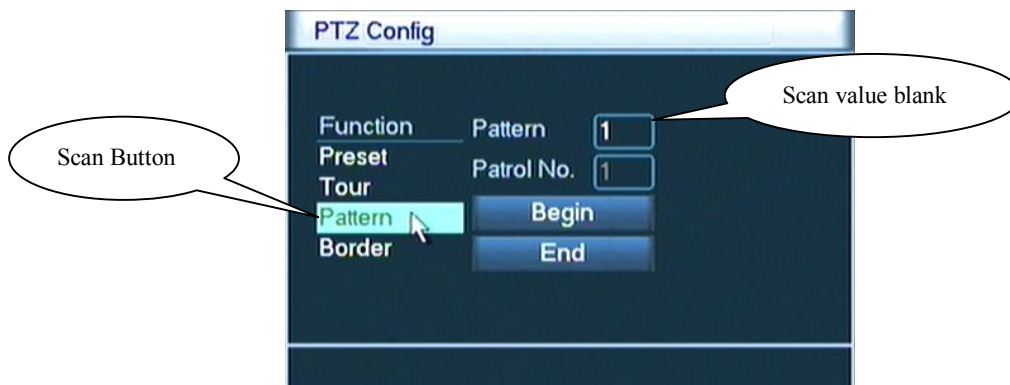

Picture 3.12 Scan Setup

2) Scan Calls

In Picture 3.8, click Page Shift button, then enter PTZ control menu as shown in Picture 3.10. Please input the number of scan in the value blank , then click Scan button, PTZ begins to work on the scan line . Click Stop button to stop.

4、Boundary Scan

In the horizontal line, set up a line, called linear sweep, PTZ repeated according to the route setting operation.

1) Boundary Scan setup

Step1: In Picture 3.8, click Direction button to turn the PTZ to preset direction, then click Setup button enter Picture 3.13, select the left boundary, return to Picture 3.8;

Step2: Please click direction arrows to adjust PTZ direction, click Setup button enter Picture3.13, then select the right boundary ,return to Picture 3.8;

Step3: Complete setup, that is the position of left and right boundary

Note: The left and right borders in the same horizontal line will be based on PTZ in the opposite direction from the left border points along the border point of rotation to the right to carry out spin cycle;

Not in the same horizontal line around the border, PTZ is only connected with the left border points, the level of trajectories as the right border of the end point in the opposite direction from the left border points along the border point of rotation to the right to carry out spin cycle.

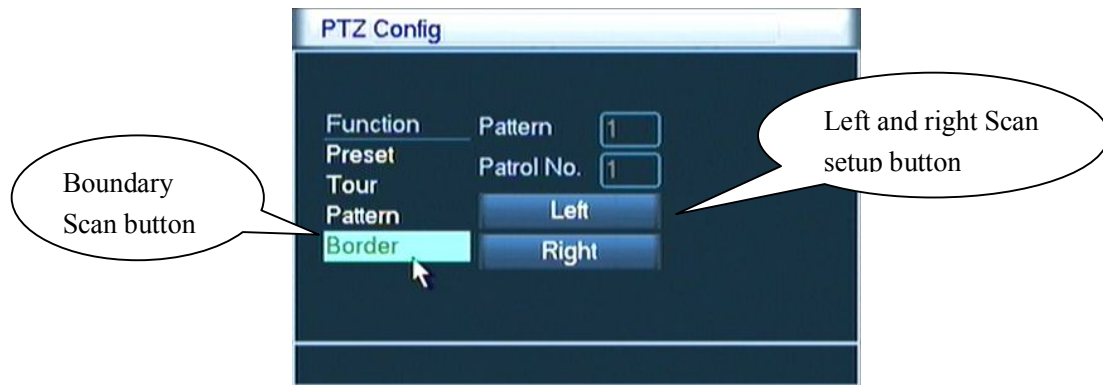

Picture 3.13 Boundary Scan Setup

2) Boundary Scan Calls

In Picture 3.8, click Page Shift button, then enter PTZ control menu as shown in Picture 3.10. Please input the number of scan in the value blank, then click Scan button, PTZ begins to work on the scan line. Click Stop button to stop.

5、 Horizontal Rotating

Click Horizontally Rotating button, PTZ begins to rotate horizontally (relative to the original position of the camera). Click the Stop button to stop.

6、 Rotate

Click on horizontal Rotating button, PTZ turn around.

7、 Reset

PTZ restart, all the data clears to 0.

8、 Page Shift

In Picture 3.10, click Page Shift button into Picture 3.14, setting auxiliary function. Auxiliary number corresponding to auxiliary switch on the decoder.

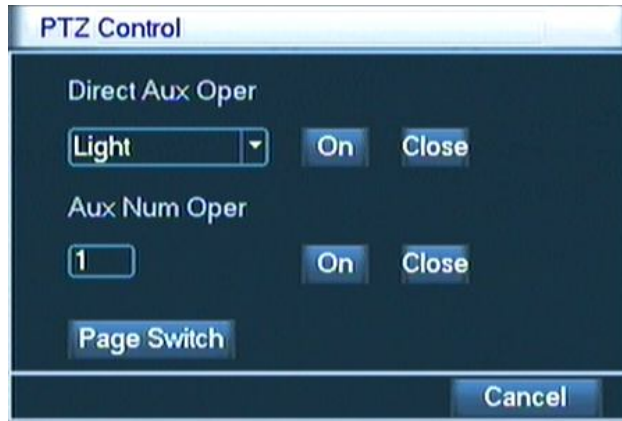

Picture 3.14 Auxiliary Function Control

【Intuitive Auxiliary Operation】 choose auxiliary equipment, select Open or Close button, switch control;

【Auxiliary Number】 The operation of corresponding auxiliary switch according to PTZ agreement;

【Page Shift】 In Picture 3.14, click Page Shift button enter the Picture 3.8 PTZ Main Menu , the menu itself can be control by the menu control buttons

3.5.4 Color Setting

Set the selective image parameters (current channel for single window display and cursor place for multi-window display). You can use the desktop shortcut menu and enter the interface. The image parameters include: tonality, brightness, contrast, saturation. You can set different parameters at different time sections.

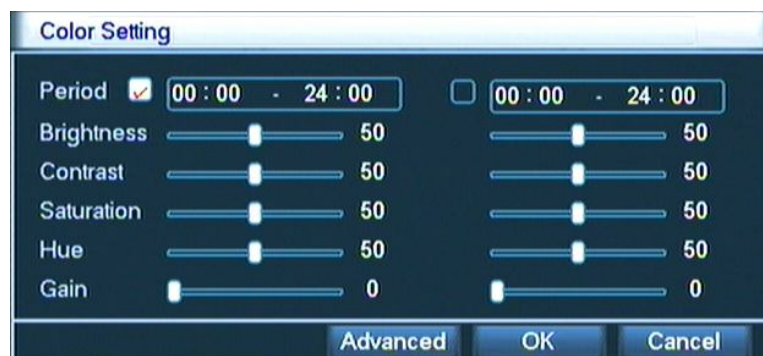

Picture 3.15 Color Setting

3.5.5 Output Adjust

Adjust output area parameters.

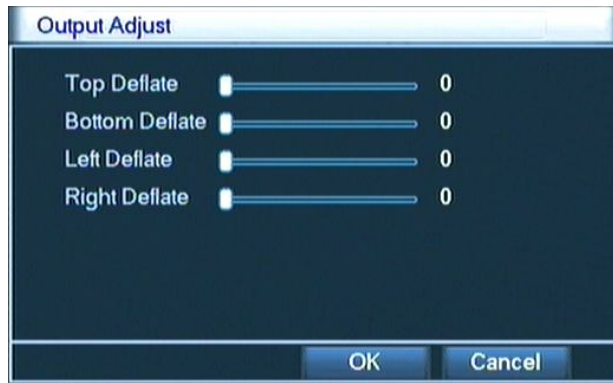

Picture 3.16 Output adjust

3.5.6 Window switch

Preview in single window/four windows/eight windows/nine windows according to the choice.

3.5.7 System information

System Information menu items include: **Hard Disk information, Log information, Stream Statistics, Online Users, and Version information.**

3.5.7.1 Hard Disk information

Display the hard disk state: hard disk type, overall capability, residual capability, the recording time and so on.

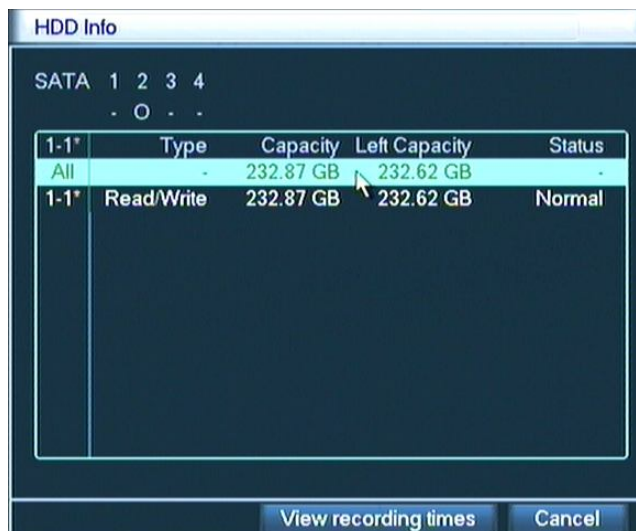

Picture 3.17 hard disk information

Notice: “○” means that the hard disk is normal. “X” means that the hard disk is broken-down.- means that there is no hard disk. If the user need to change the damaged hard disk, you must shut down the DVR and take up

all the damaged hard disks then install a new one.

“*” behind serial number means the current working disk such as 1*. If the corresponding disk is damaged, the information will display “? ”.

3.5.7.2 Log information

Look up system log according to the set mode.

Log information include: system operation, configuration operation, data management, alarm affair, recording operation, user management, file management and so on. Set the time section to look up and click the look up button. The log information will display as a list. (one page is 128 items) Press **Page up** or **Page down** button to look up and press **delete** button to clear all the log information.

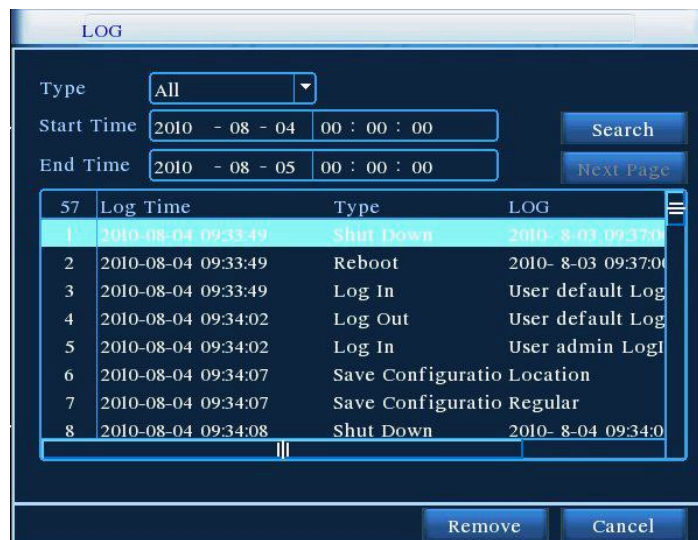

Picture 3.18 log information

3.5.7.3 Code stream statistics

Display the code stream (Kb/S) and hard disk capability (MB/H) in real time. It displays as the wave sketch map.

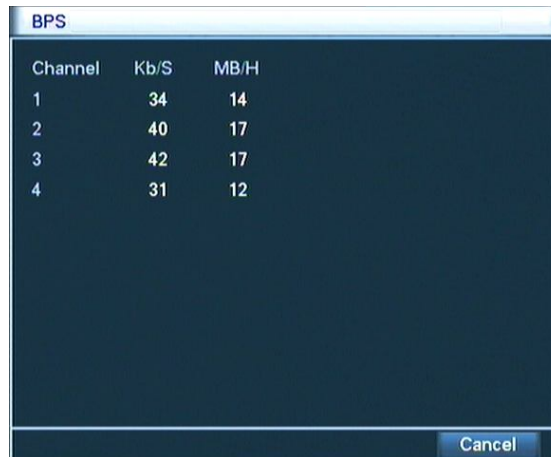

Channel	Kb/S	MB/H
1	34	14
2	40	17
3	42	17
4	31	12

Picture 3.19 code stream statistics

3.5.7.4 Online user

Look up the network user information in the local DVR. You can choose the network user and cut the connection. Then the user is locked until next boot-strap.

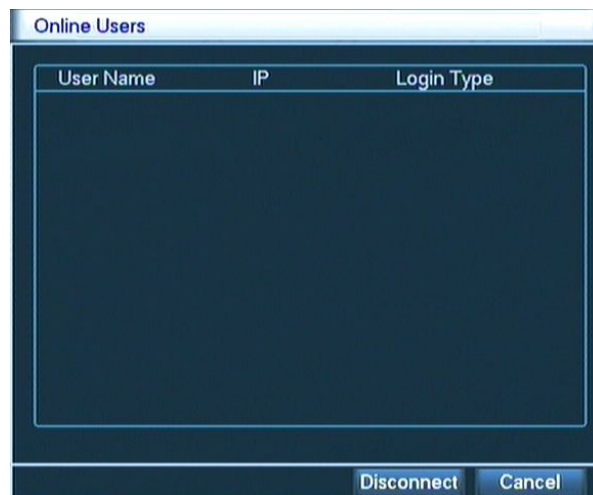

User Name	IP	Login Type
-----------	----	------------

Picture 3.20 online user

3.5.7.5 Edition information

Display the basic information such as hardware information, software edition, issue data and so on.

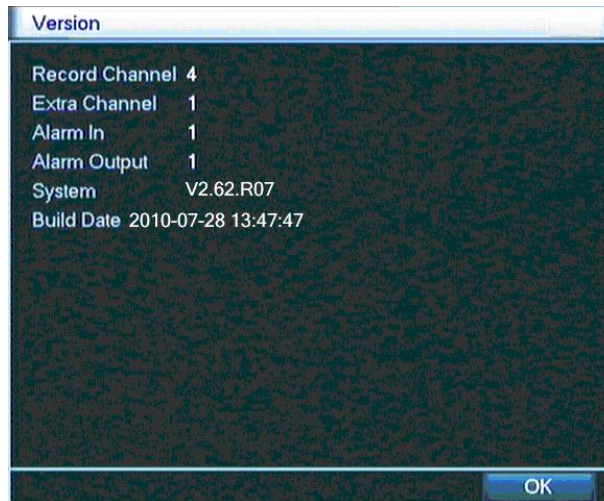

Picture 3.21 edition information

3.5.8 Logout

Logout, shut down the system or reboot up. You can use the desktop shortcut menu or enter [main menu].

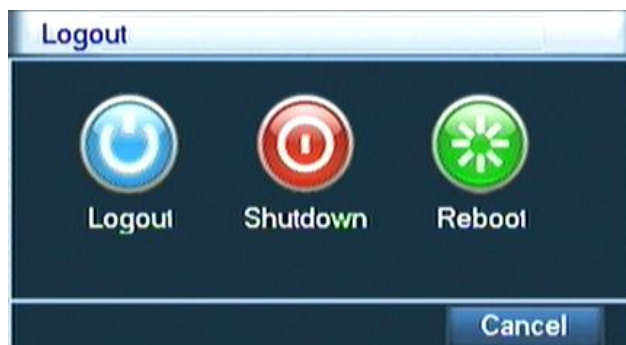

Picture 3.22 shut down the system

【Logout】 Quit the menu. Offer password next entrance.

【Shutdown】 Quit the system. Turn off the power supply.

When press the shut down button, there is schedule hint. After three seconds, the system is shut down. Cancel midway is of no effect.

【Reboot】 Quit the system. Reboot up the system..

4. Main Menu

When User login, the system main menu is shown as below.



Picture4.0 Main menu

4.1 Main Menu navigation

Main Menu	Sub menu	Function
Record Mode		Set the recording status of each channel
Record config		Set the recording configuration, recording type, recording time section
Encode		Set main(assistant)coding parameter: code mode, resolving ability, frame rate, code stream control, image quality type, code stream value, frame between value, video/audio enable
HDD manage		Set appointed hard disk as read-write disc, read-only disc or redundant disc, clear data, resume data, format HDD and so on
Network	Netservice	Set basic network parameters, DHCP,DNS parameters, network high speed download and PPPOE、NTP、Email、IP purview、DDNS parameter、FTP、Wireless Config、 Mobile Monitor、UPNP

PTZ config		Set channel, PTZ protocol, address, baud rate, data bit, stop bit, check
Alarm	Motion detection	Set motion detect alarm channel, sensitivity, area, linkage parameters: defending time section, alarm output, screen hint, recording, PTZ, patrol
	Video shelter	Set camera mask alarm channel, sensitivity, linkage parameters: defending time section, alarm output, screen hint, recording, PTZ, patrol
	Video loss	Set video loss alarm channel, linkage parameters: defending time section, alarm output, screen hint, recording, PTZ, patrol
	Alarm input	Set alarm input channel, equipment type, linkage parameters: defending time section, alarm output, screen hint, recording, PTZ, patrol
	Alarm output	Set alarm mode: configuration, manual, shut down
System	General	Set system time, data format, language, hard disk full time operation, machine number, video format, output mode, summertime, stay time
	GUI Display	Set channel name, preview hint icon state, transparency, cover area, time title, channel time fold and Set patrol mode and interval time
	Account	Modify user, team or password. Add user or team. Delete user or team.
	Upgrade	Upgrade to the DVR software system
	Resume config	Resume setup state: common setup, code setup, recording setup, alarm setup, network setup, network service, preview playback, serial port setup, user management
	Backup	Detect or format backup equipment, back the selective files
	Device Info	Provision of equipment interface device information to facilitate the understanding of our customers use.
Auto Maintain	Users can set the device to automatically reboot the system on their own time, and automatically delete the file set time period.	

4.2 Record Mode

Control the recording status of each channel, through the **【main menu】** > **【record mode】** enter the record mode interface, and also be right on the desktop directly into the shortcut menu.

The concrete operation, please refer to the chapter of "3.5.1 Record Mode."

4.3 Record Config

Set the recording parameters in the surveillance channel. The system is set 24 hours consecutive recording in the first startup. You can enter [main menu]> [recording config] to set.

Note: There is at least one read-write hard disk. (Detail operation please refer to chapter 4.5 HDD manage)

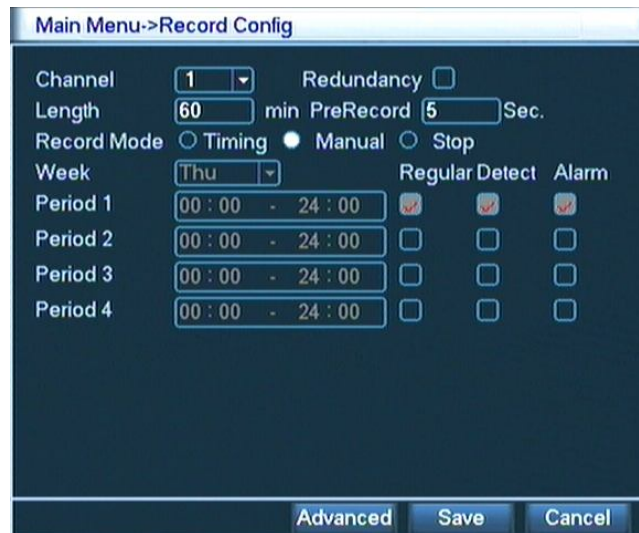

Picture 4.1 Record config

【channel】 Choose the corresponding channel number to set the channel. Choose the all option to set the entire channels.

【redundancy】 Choose the redundancy function option to implement the file double backup function. Double backup is writing the video files in two hard disks. When you do the double backup, make sure that there are two hard disks installed. One is read-write disk and the other is redundant disk. (refer to 4.5)

【length】 Set the time length of each video file. 60minutes is default value.

【pre-recording】 Record 1-30 seconds before the action. (time length is decided by the code stream)

【recording control】 Set video state: configuration, all or stop.

configuration: Record according to the set video type (common, detection and alarm)and time section.

all: Click the all button and the according channel is recording no matter the channel in any state.

stop: Click the stop button and the according channel stops recording no matter the channel in any state.

【time section】 Set the time section of common recording, The recording will start only in the set range.

【recording type】 Set recording type: regular, detection or alarm.

regular: Perform the regular recording in the set time section. The video file type is “R”.

detection: Trigger the “motion detect”, “camera mask” or “video loss” signal. When above alarm is

set as opening recording, the “detection recording” state is on. The video file type is “M”.

alarm: Trigger the external alarm signal in the set time section. When above alarm is set as opening recording, the “detection recording” state is on. The video file type is “A”.

Note: Refer to chapter 4.8 to set corresponding alarm function.

4.4 Encode setup

Set the video/audio code parameter: video file, network surveillance and so on.



Picture 4.2 encode setup

【Channel】 Choose the channel number.

【Compression】 Standard H.264.

【Resolution】 Resolution type:D1/HD1/ CIF / QCIF.

【Frame Rate】 P: 1 frame/s~25 frame/s; N: 1 frame/s~30 frame/s

【Bit Rate Type】 You can choose constant code stream(CBR) or variable code stream(VBR). When you choose the variable code stream there are six image quality options.

【Bit Rate】 Set the code stream value to modify the image quality. The larger code stream value the better image quality.

Reference range: D1(1000~1500kbps) , CIF (400~600kbps) , QCIF(64~512kbps)

【Video/Audio】 When the icons are all in reverse displayed, the video file is video and audio multiplex stream.

【Auxiliary stream】 Video/audio tick the enable auxiliary stream. It can achieve multi-channel recording and remote real-time monitoring with ADSL internet,and for multi-channel playback at the same time.

【Channel number】 First select the channel number, then select the following audio and video are open;

Resolution, frame rate, stream control, code stream value parameters and the independent channel the same settings.

4.5 HDD manage

Configure and manage the hard disk. The menu displays current hard disk information: hard disk number, input port, type, status and overall capability. The operation include: setup the write-read disk, read-only disk, redundant disk, hard disk format, resume default. Choose the hard disk and click the right function button to execute.

Note: write-read disk: The equipment can write or read data.

read-only disk: The equipment can read data but can not write data.

redundant disk: Double backup the video files in the write-read disk.

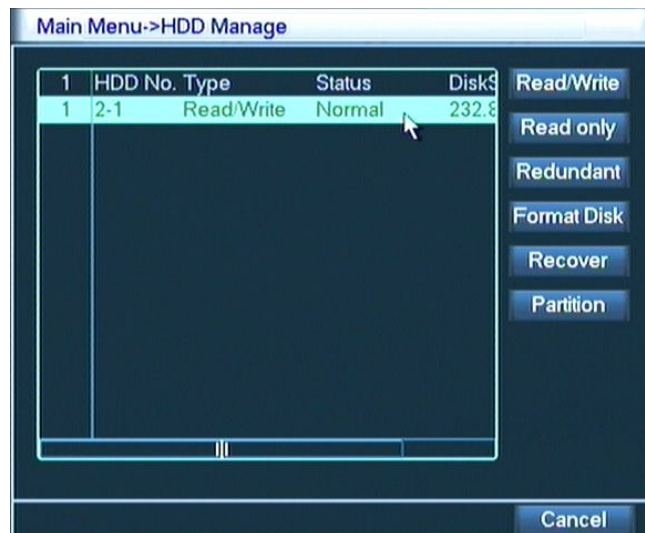

Picture4.3 hard disk management

4.6 Network setup

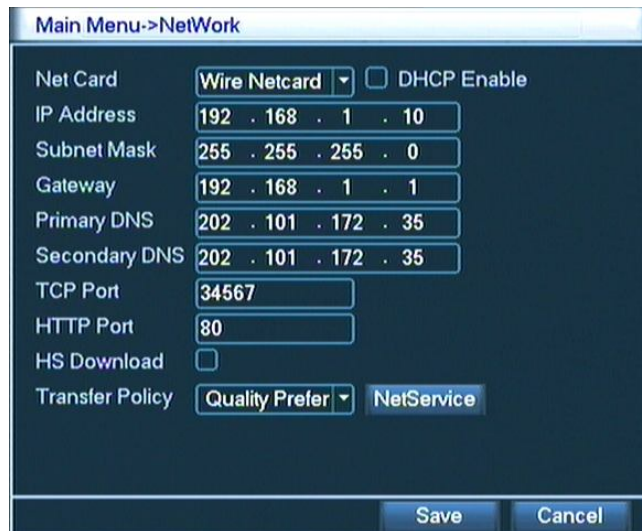

Picture4.4 network setup

【network card】 You can choose cable network card or wireless network card.

【DHCP Enable】 Obtain IP address automatically.

Note: DHCP server is preinstalled.

【IP address】 Set the IP address. Default: 192.168.1.10.

【Subnet mask code】 Set the subnet mask code. Default: 255.255.255.0.

【Gateway】 Set the default gateway. Default: 192.168.1.1.

【DNS setup】 Domain Name Server. It translates the domain name into IP address. The IP address is offered by network provider. The address must be set and reboot then it works.

【TCP port】 Default: 34567.

【HTTP port】 Default: 80.

【Max Connection】 Network user connection number , the set range is 0-10.

【LAN Download】 Internet High-Speed Download;

【network transmission strategy】 There are three strategies: self-adaption, image quality precedence and fluency precedence. The code stream will adjust according to the setup. Self-adaption is the tradeoff between the image quality precedence and fluency precedence. Fluency precedence and self-adaption are valid only when the assistant code stream is turned on. Otherwise image quality precedence is valid.

4.6.1 Network service

Advanced network functions on the configuration, double-click the 【Net Service】 button to enter the Picture 4.5 interface, first select the Network Services entry and click the Settings button, or double-click the

service parameter configuration items.

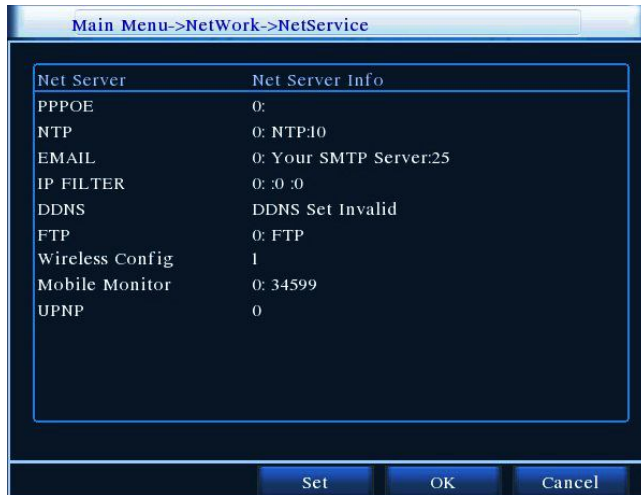

Picture 4.5 network service

【PPPoE setup】

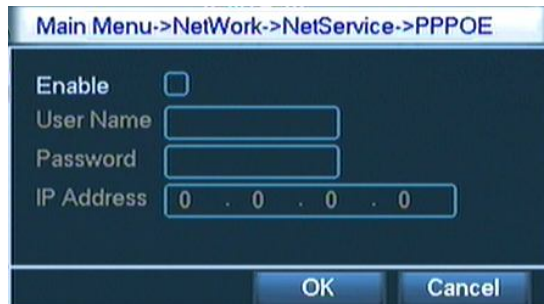

Picture4.6 PPPOE setup

Input the user name and password that ISP (Internet service provider) provides. After saving it reboot up your system. Then the DVR will build a network connection based on PPPoE. The IP address will change into dynamic IP address after above operation is well done.

Operation: After PPPoE dialing successfully look up the IP address in the [IP address] and obtain the current IP address. Then use this IP address to visit the DVR through user port.

【NTP setup】

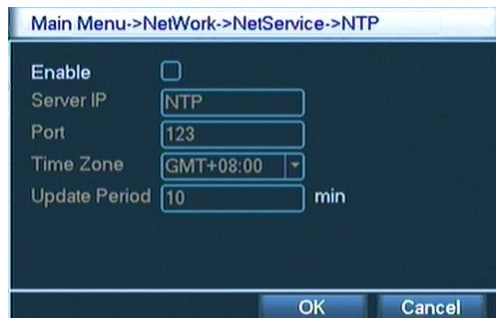

Picture 4.7 NTP setup

The NTP server must be installed in the PC.

Host computer IP: Input the IP address installed NTP server.

Port: Default: 123. You can set the port according to NTP server.

Time zone: London GMT+0 Berlin GMT +1 Cairo GMT +2 Moscow GMT +3 New Delhi GMT +5
Bangkok GMT +7 Hongkong Beijing GMT +8 Tokyo GMT +9 Sydney GMT +10 Hawaii GMT-10
Alaska GMT-9 Pacific time GMT-8 American mountain time GMT-7 American mid time GMT-6
American eastern time GMT-5 Atlantic time GMT-4 Brazil GMT-3 Atlantic mid time GMT-2.

Update cycle: The same with the NTP server check interval. Default: 10minutes.

【EMAIL setup】

If the alarm is turned on or the alarm linkage photos are taken, send an email about the alarm information and the photos to appointed address.

Picture 4.8 EMAIL setup

SMTP server: Email server address. It could be an IP address or domain name. Domain name can be translated only it is the correct DNS configuration.

Port: Email server port number.

SSL: Decide whether using Secure Socket Layer protocol to login.

User: Apply the email server user name.

Password: Input the password corresponding to the user.

Sender: Set the email sender address.

Receiver: Send the email to appointed receivers when the alarm is turned on. You can set three receivers at most, and each receiver separate by “;”(Semicolon + Space), receiver and sender can use same email.

Subject: You can set as you wish.

【IP purview setup】

When choosing the white list, only the listed IP address can connect the DVR. The 64 IP addresses are supportive in the list.

When choosing the black list, the listed IP address can not connect the DVR. The 64 IP addresses are supportive in the list.

You can delete the set IP address by $\sqrt{\quad}$ in the options.

Note: When the same IP address is in the white and black list at the same time, the black list precedence is higher.

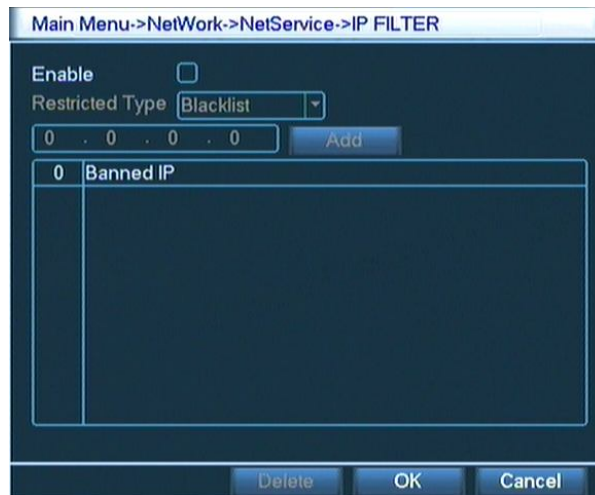

Picture 4.9 IP purview setup

【DDNS】

It is the abbreviation of dynamic domain name server.

Local domain name: Provide the domain name registered by DDNS.

Server domain name: Provide the domain name of DDNS.

Port: Provide the visit port number of DDNS.

User name: Provide the account registered by DDNS.

Password: Provide the password registered by DDNS.

When the DDNS is successfully configured and start, you can connect the domain name in the IE address column to visit.

Note: The DNS setup must be configured correctly in the network setup.

Picture 4.10 DDNS setup

【FTP】

FTP used when there get alarm,or alarm linkage to recording,snap pictures, you can specify the FTP server to upload video and capture specific images.

Picture 4.11 FTP setup

【Enable】 Select ,enable the FTP function.

【Server IP】 FTP server's IP address

【Port】 FTP set up the domain when the port number, default port 21.

【User name】 Permission to log FTP user name.

【Password】 User's password.

【Max File Length】 Upload files for each package the max length,default is 128M.

【DirName】 Upload file directory.

【Wireless config】

Dial-up Internet access through 3G card to realize the client access device, the device configuration (**Note: only for some models**)

Picture 4.12 Wireless config setup

【Enable】 Select ,enable the Wireless function.

【Type】 Dial type, the default auto.

【Wireless AP】 3G access point,the default OK.

【Dial Number】 3G dial-up number,the default OK

【User Name】 Dial-up of 3G User Name.

【Password】 Dial-up user's password.

【IP Address】 Dial-up IP address number obtained.

【Mobile monitor】

Access through mobilephone, mapping the port on the Router. By agreement of the client device monitoring and operation.

Picture 4.13 Mobile monitor setup

【Enable】 Select ,enable the Mobilephone function.

【Port】 Port for mobilephone view, need mapping the port on Router.

【UPNP】

UPNP protocol will be automatic port forwarding on the Router, before use this feature, make sure UPNP feature is enabled on the router.

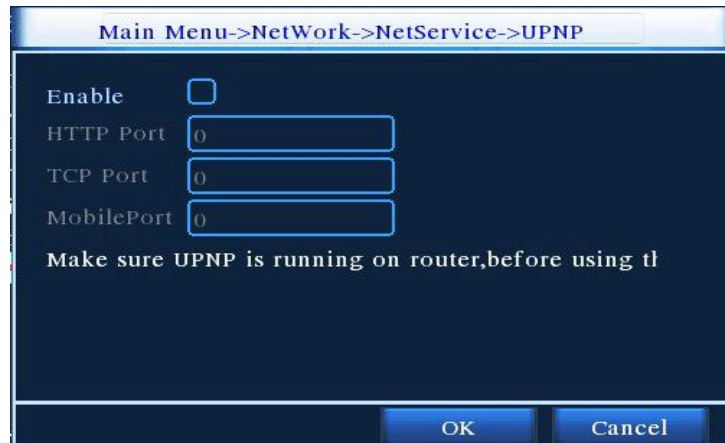

Picture 4.14 UPNP setup

【Enable】 Select , enable the Mobilephone function.

【HTTP Port】 Router automatically assigns the device port number, while browsing by IE, need add the port number.

【TCP Port】 Router automatically assigns the device port number, while use the client software to monitor, required by the port number

【Mobile Port】 Router automatically assigns the device port number, mobilephone monitoring through the port number

4.7 PTZ config

PTZ Device		RS485 Device	
Channel	1	Protocol	NONE
Protocol	PELCOD	Address	1
Address	1	Baudrate	9600
Baudrate	9600	Data Bits	8
Data Bits	8	Stop Bits	1
Stop Bits	1	Parity	None
Parity	None	Monitors	0
Monitors	0		

Picture 4.15 PTZ setup

【channel】 Choose the dome camera input channel.

【protocol】 Choose the corresponding dome protocol. (PELCOD as an example)

【address】 Set as the corresponding dome address. Default: 1. (Note: The address must be consistent with the dome address.)

【baud rate】 Choose the corresponding dome baud rate length. You can control the PTZ and camera. Default: 115200.

【date bit】 Include 5-8 options. Default: 8.

【stop bit】 Include 2 options. Default: 1.

【check】 Include odd check, even check, sign check, blank check. Default: void.

4.8 Alarm setup

Alarm functions include: **Motion Detect, Video Blind, Video Loss, Alarm Input and Alarm Output.**

4.8.1 Motion Detect

When system detects the motion signal that reaches the set sensitivity, the motion detect alarm is on and the linkage function is turned on.

Note: The Advanced button with the right mouse button.

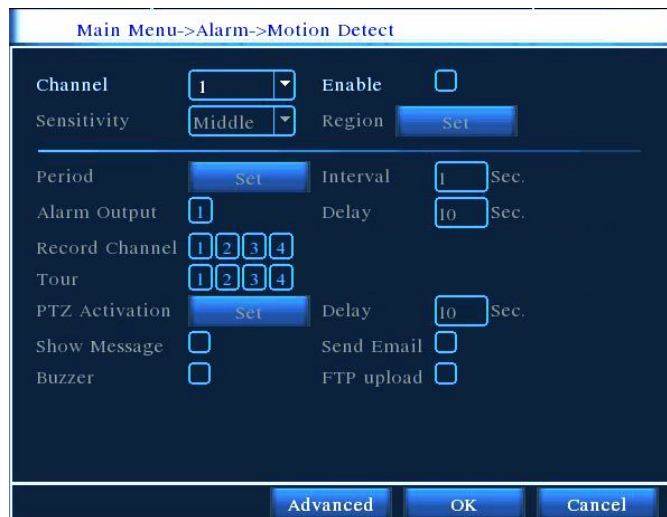

Picture 4.16 motion detect

【channel number】 Choose the set motion detect channel.

【enable】 ■ means that the motion detect function is on.

【sensitivity】 Choose in the six options according to the sensitivity.

【area】 Click setup and enter the set area. The area is divided into PAL22X18. Green block means the current cursor area. Yellow block means the dynamic detect defensive area. Black block means the unfenced area.

You can set the area as followed, Drag the mouse and draw the area.

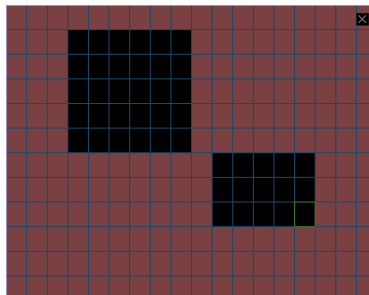

Picture 4.17 set the area

【time section】 Trigger the motion detect signal in the set time section. You can set according to week or set uniformly. Each day is divided into four time sections. ■ means the set valid.

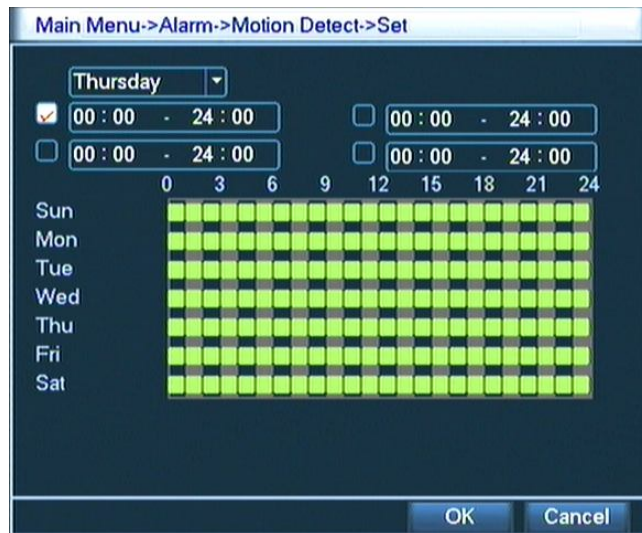

Picture 4.18 set the time section

【interval】 Only one alarm signal is turned on even there are several motion detect signals in the set interval.

【alarm output】 Start the external equipment of corresponding linkage alarm when the motion detect alarm is turned on.

【delay】 Delay a few moments and stop when the alarm state is turned off. The range is 10~300 seconds.

【recording channel】 Choose the recording channel (multiple option supportive). Trigger the video signal when the alarm is turned on.

Note: Set in the [recording setup] and perform the linkage recording. Start detecting video files in the corresponding time section.

【tour】 ■ means that the selective channel is single window alternate patrol preview. The interval is set in the [system setup] > [alternate patrol].

【PTZ linkage】 Set the PTZ linkage when the alarm is turned on.

Note: PTZ linkage is set in the [shortcut menu] > [PTZ control]. Set the patrol between spots, trail patrol and so on.



图 4.19 PTZ linkage

【Recording delay】 After alarm stop, the extended period of time to stop alarm recording, the range is 10~300 seconds.

【Screen hint】 Pop the alarm information dialog box in the local host computer screen.

【EMAIL】 ■ means sending an email to user when the alarm is turned on.

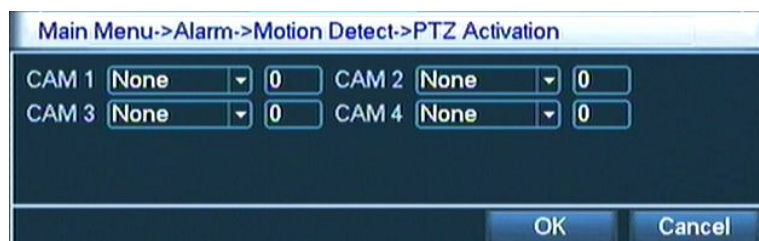
Note: Set in the 【network service】 and send an email.

【Beep】 Alarm occurs, the equipment issue "Didi" the sounds of two long ring.

【FTP upload】 Alarm occurred while sending alarm events to the FTP server.

4.8.2 Video Blind

When the video image is influenced by the environment such as bad brightness or reaching the set sensitivity parameter, the camera mask function is turned on and the linkage function is turned on.

Note: The Advanced button with the right mouse button.



Picture 4.20 Video Blind

Set method: refer to Chapter 4.8.1. Motion Detect.

4.8.3 Video Loss

When the equipment can not obtain the channel video signal, the video loss alarm is turned on and the linkage function is turned on.

Note: The Advanced button with the right mouse button.

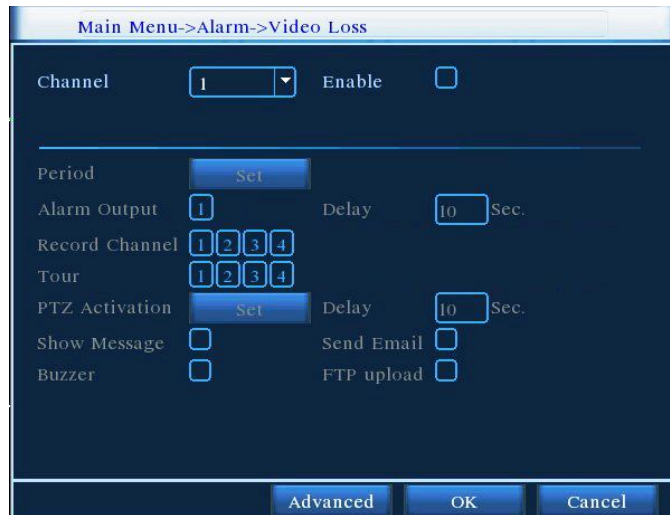

Picture 4.21 video loss

Set method: refer to Chapter 4.8.1. Motion Detect

4.8.4 Alarm input

When the equipment obtains the external alarm signal, the alarm function is turned on.

Notice: Advanced same the right mouse button



Picture 4.22 alarm input

Set method: refer to Chapter 4.8.1. Motion Detect

4.8.5 Alarm output

Please check current channel status: “○” means it is not in alarming status, “●” means it is in alarming status.

You can use desktop shortcut menu or click [main menu]> [alarm function]> [alarm output] to enter the alarm output screen.

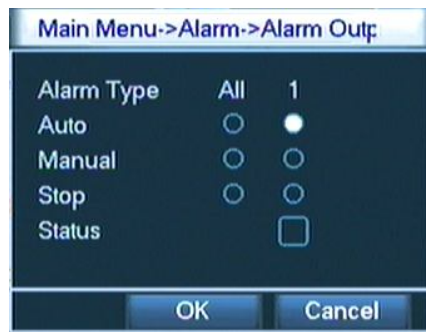

Picture 4.23 alarm output

【configuration】 Alarm is on according to the configuration.

【All】 Click the all button and the according channel is alarming no matter the channel in any state.

【stop】 Click the stop button and the according channel stops alarming no matter the channel in any state.

4.9 System setup

Set the system parameters such as General setup, GUI Display setup, Account setup, Upgrade, Restore config, Backup, Device info and Auto maintain.

4.9.1 General setup



Picture 4.24 regular setup

【system time】 Set the system data and time.

【data format】 Choose the data format: YMD, MDY, DMY.

【list separator】 Choose list separator of the data format.

【time format】 Choose time format: 24-hour or 12-hour.

【language】 English or Chinese.

【hard disk full】 Choose stop: Stop recording when the hard disk is full.

Choose cover: Cover the earliest recording files and continue recording when the hard disk is full.

【number】 Only when the address button in the remote controller and the corresponding DVR number is matched, the remote operation is valid.

【video format】 PAL or NTSC.

【latency time】 Set the latency time in 0-60. 0 means no latency time.

【Car plate】 Use for mobile DVR.

【summer time】 Choose the summer time option and pop the dialog box as followed.



Picture 4.25 summer time (week) setup

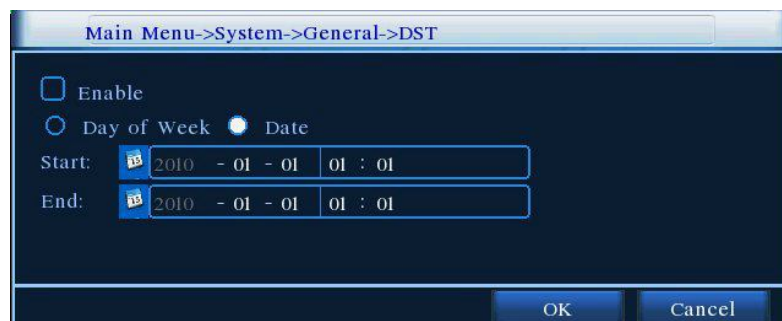

Picture 4.26 summer time (data) setup

4.9.2 GUI Display

Configure the video output parameters including the front output mode and code output mode.

Front output: In the local preview mode include: channel name, time title, channel title, recording status, alarm status, code stream information, transparency and cover area.

Code output: In the network surveillance and video file mode include: channel name, time title, channel title,

recording status, alarm status, code stream information, transparency and cover area.

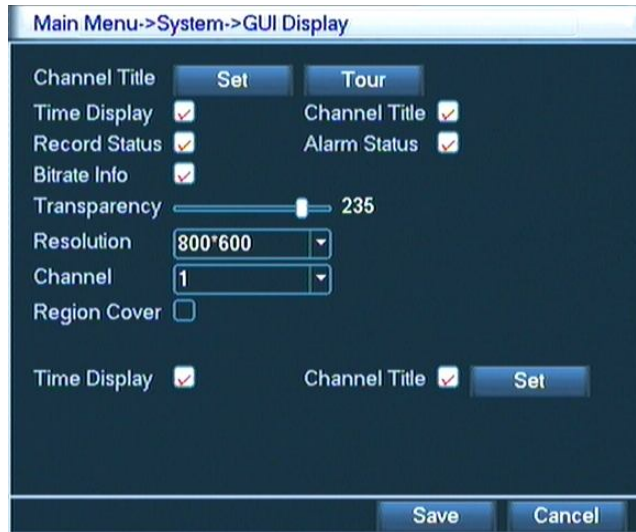

Picture 4.27 GUI display

【channel name】 Click the channel name modify button and enter the channel name menu. Modify the channel name. The 16 Chinese characters and 25 letters are supportive.

【time title】 ■ means the selective state. Display the system data and time in the surveillance window.

【channel title】 ■ means the selective state. Display the system channel number in the surveillance window.

【recording status】 ■ means the selective state. Display the system recording status in the surveillance window.

【alarm status】 ■ means the selective state. Display the system alarm status in the surveillance window.

【code stream information】 ■ means the selective state. The ninth window displays the code stream information in the nine-window preview status.

【transparency】 Choose the background image transparency. The range is 128~255.

【resolution】 set display resolution.

【channel】 Choose the set code output channel number.

【cover area】 ■ means the selective state. Click the cover area button and enter the corresponding channel window. You can cover the arbitrary using mouse.

【time title】 same with **【channel】** Set the time and channel title display position title.

【Tour】 Set the patrol display. ■ means that the patrol mode is turned on. You can choose the single window, four windows, nine windows, sixteen windows patrol display or single display.

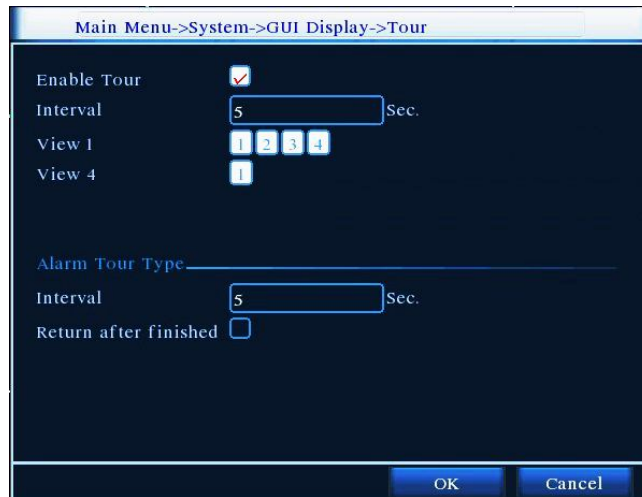

Picture 4.28 Tour setup

【interval】 Set the patrol switch interval. The set range is 5-120 seconds.

Note: At the preview mode,  /  means turn off/on the patrol.

4.9.3 Account management

Manage the user purview.

- Note:**
1. The char length is 8 bytes at most for the following user and user team name. The blank ahead or behind the char string is invalid. The middle blank in the char string is valid. Legal char include: letter, number, underline, subtraction sign, dot.
 2. There is no limit in the user and user team. You can add or delete the user team according to user definition. The factory setup include: user\admin. You can set the team as you wish. The user can appoint the purview in the team.
 3. The user management include: team/ user. The team and the user name can not be the same. Each user only belongs to one team.

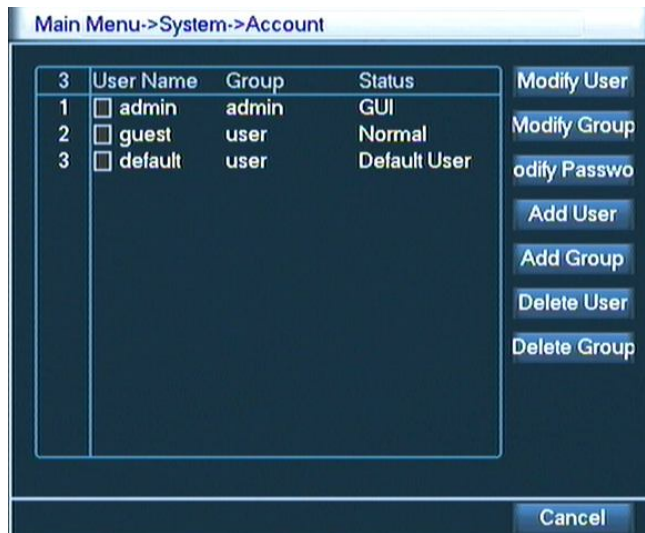

Picture 4.29 user management

【modify user】 Modify the existed user attribute.

【modify team】 Modify the existed team attribute.

【modify password】 Modify the user password. You can set 1-6 bit password. The blank ahead or behind the char string is invalid. The middle blank in the char string is valid.

Note: The user who possess the user control purview can modify his/her own or other user password

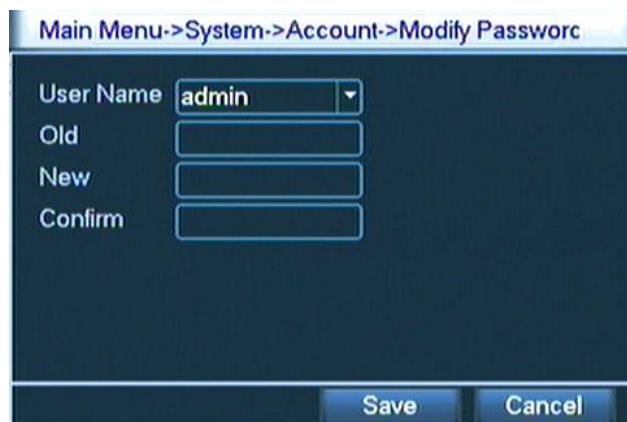

Picture 4.30 modify password

【add user】 Add a user in the team and set the user purview. Enter the menu interface and input the user name and password. Choose the team and choose whether cover using the user. Cover using means that the account can be used by multiple users at the same time.

Once choose the team the user purview is the subclass of the team.

We recommend that the common user's purview is lower than the advanced user.

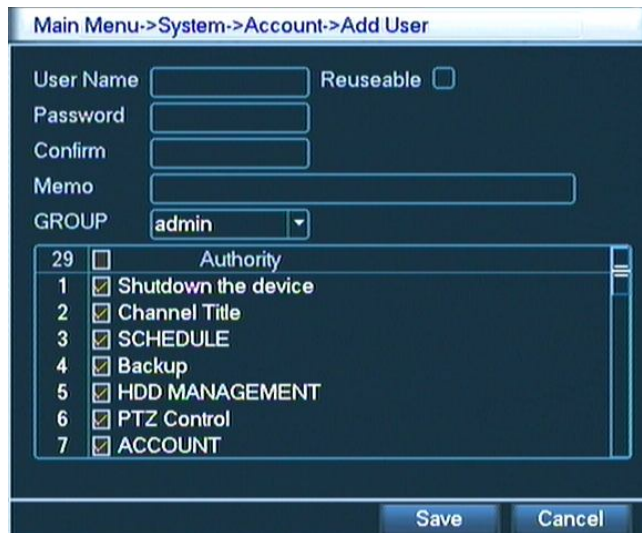

Picture 4.31 add user

【add team】 Add a user team and set the purview. There are 36 different purviews: shut down the equipment, real time surveillance, playback, recording setup, video file backup and so on.

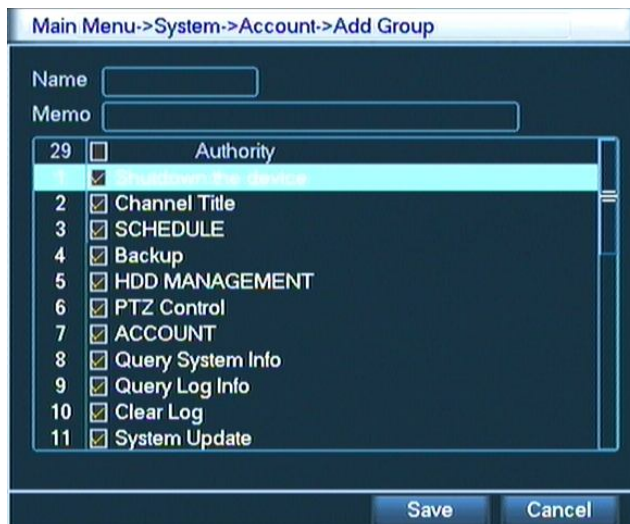

Picture 4.32 add team

【delete user】 Delete the current user. Choose the user and click delete user button.

【delete team】 Delete the current team (there is no need to ensure that the team users). In Picture 4.25, click the delete team button in Picture 4.29, select the need to remove the team, click the delete button. Choose the team and click delete team button.

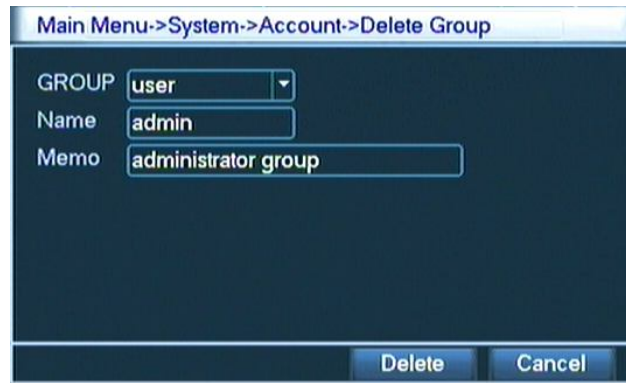

Picture 4.33 delete team

4.9.4 Upgrade



Picture 4.34 upgrade

【upgrade】 choose USB interface.

【upgrade file】 choose the file which need upgraded.

4.9.5 Restore config

The system resume to the default setup. You can choose the items according to the menu.

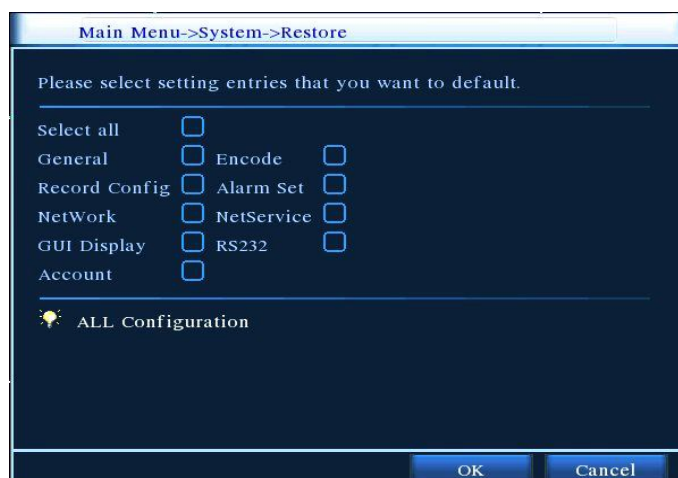

Picture 4.35 resume default

4.9.6 Backup

You can backup the video files to external storage through setup.

Note: The storage must be installed before the file backup.If the backup is terminated, the already copy files can be playback individually.

If the backup is stop midway,the already copy files also can be playback individually.

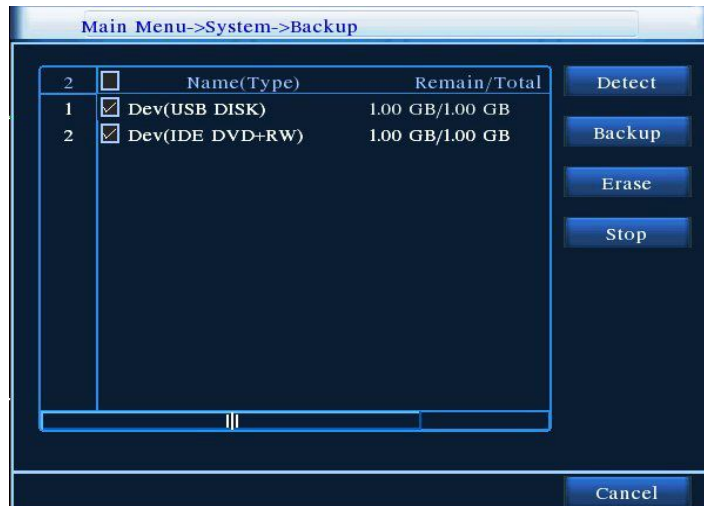

Picture 4.36 detect the equipment

【detect】 Detect the storage connected with the DVR such as hard disk or universal disk.

【erase】 Choose the file to delete and click erasure to delete the file.

【stop】 Stop the backup.

【backup】 Click “backup” button and the dialog box is popped up. You can choose the backup file according to the type, channel and time.

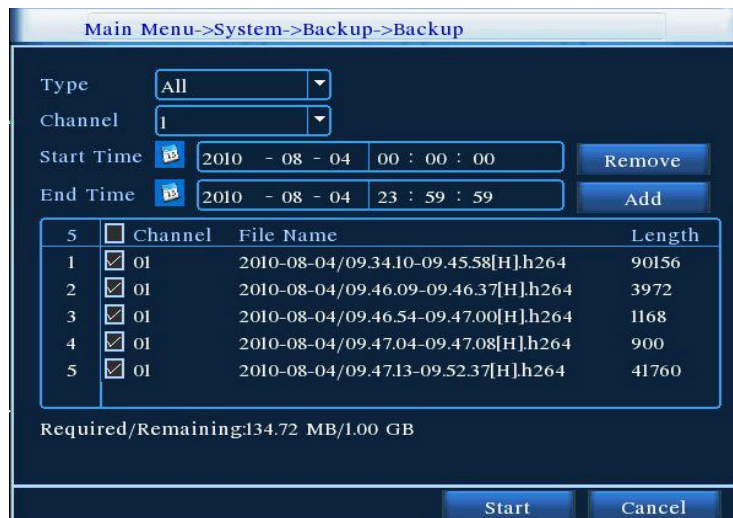

Picture4.37 file backup

remove: Clear the file information.

add: Show the file information satisfying the set file attributes.

start/pause: Click the play button to start the backup and click the pause button to stop the backup.

cancel: During backup you can exit the page layout to carry out other functions.

4.9.7 Device Info

Provision of equipment interface device information to facilitate the understanding of our customers use.

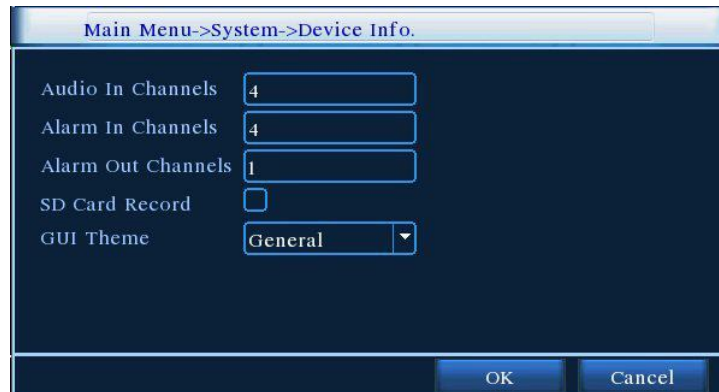

Picture4.38 device info

4.9.8 AutoMaintain

Users can set the device to automatically reboot the system on their own time, and automatically delete the file set time period.

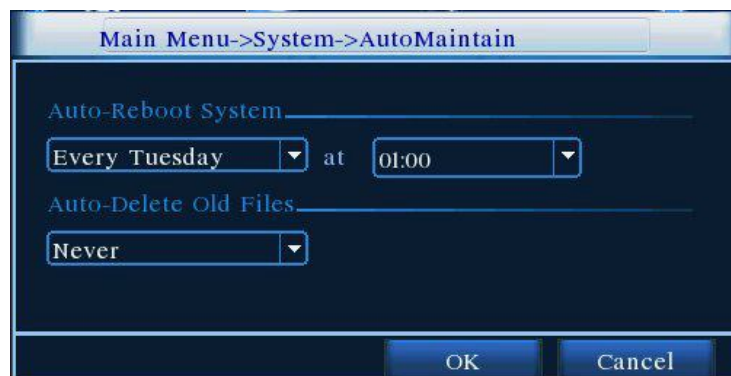

Picture4.39 auto maintain

5. Netview and Management

5.1 WEB network control

1、 Net connection

Before the WEB operation, need to connect this device with the network.

★ Note: Some models before in networking, PC must be installed machine tools in CD-ROM package of the ActiveX plug-in, otherwise IE can not connect

Step 1: Place the device properly access network;

Step 2: Give the host computer and the devices were set IP address, subnet mask and gateway (such as network routing equipment is not requested the allocation of the IP address of the same network segment, if the network has routing equipment, you need set up the corresponding gateway and subnet mask), the device's network settings, please check **【main menu】 > 【network settings】** .

(This device and PC need the same IP network segment. If can't connect, please check the IP of this device is connected fluent)

2、 Login

After the net connect, then login into.

Step 1: connect the device. Open a web browser, enter the IP address of the login device in the address bar. As the device with IP address 192.168.1.10 for example, then enter: http://192.168.1.10 in the address bar and connections.

If the PC connect the device at first time, when open system, the security warning will pop up whether to accept the WEB control web.cab, please choose to accept the user, the system will automatically identify the installation. (If the system is prohibited to download, please confirm whether you have other prohibited controls to download plug-ins, and reduce the IE security level)

Connection as shown below will pop up after the success of the interface.

Note: The first landing, the system will be registered, need to wait for 2 ~ 3 minutes.

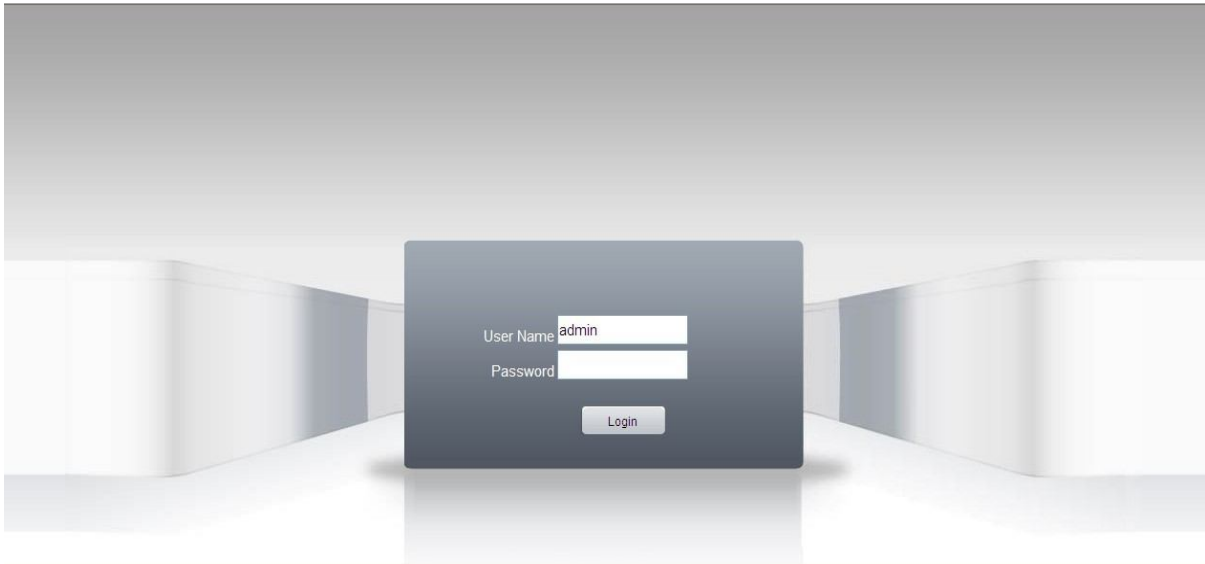

Picture 5.1 WEB Login interface

Step 2: Login. Enter the user name and password, the company factory default administrator user name admin, password is blank. After Logged ,please promptly change the administrator password.

Login is successful, display the interface as shown below.

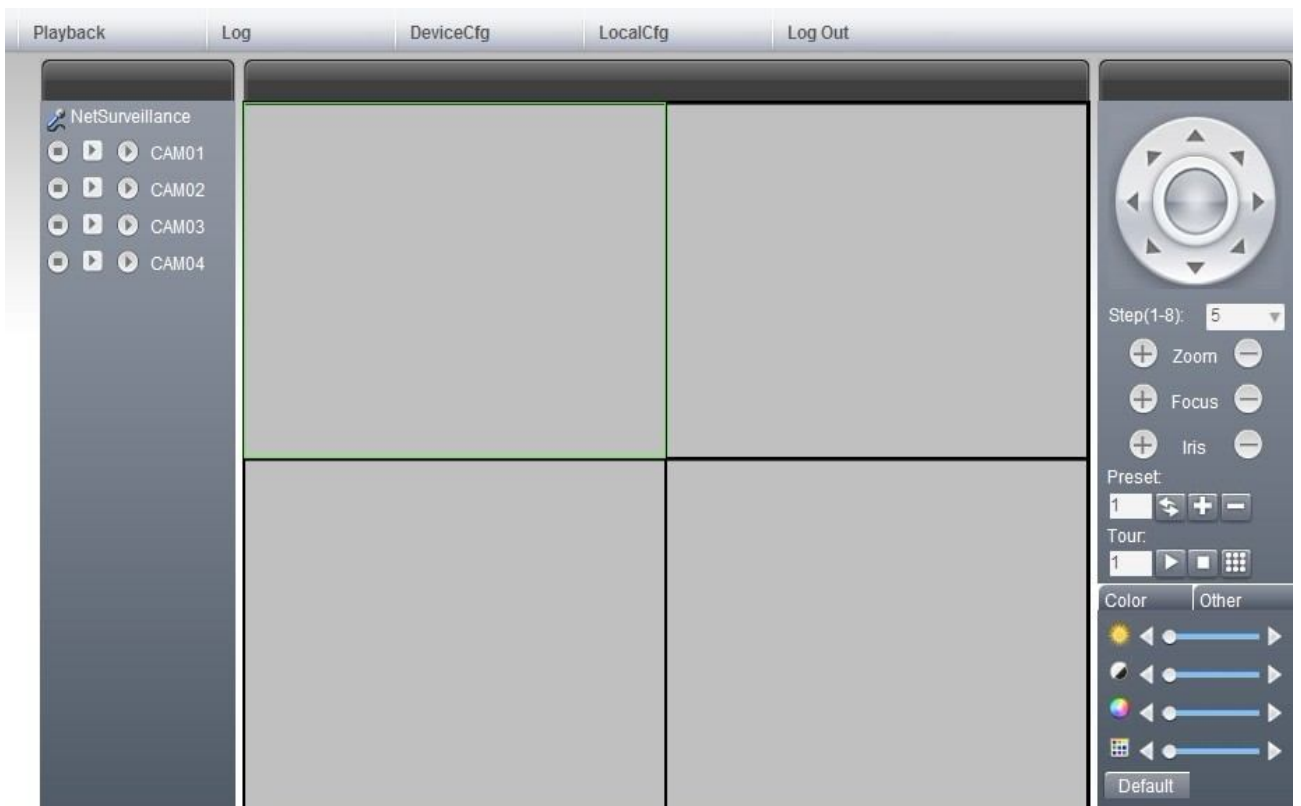

Picture 5.2 WEB control interface

3、 WEB Control

In Picture 5.2 WEB control interface to operate WEB.

1、 Menu Segment

Choose the preview mode;

2、 Playback

Enter into the playback mode,support 4chanel playback at the same time;

3、 Log

Display the log information;

4、 Local Configure

For WEB-side alarm settings, and checking the version information of WEB system;

5、 Channel Control

Select the control channel, the cursor is located in the window at controlled access, click the right mouse button, select the corresponding channel function operation;

When the cursor at the upper right corner of the channel, right-click, select the corresponding channel stream type.

5.2 Client CMS software operation

CMS software is used on the same PC, support control multiple DVRs at the same time.

Please take out the CD-ROM in the accessories, copy the CMS install software in the CD-ROM After installation on the local PC,double click the “CMS”,open the control interface appears in Picture 5.3, default without password, the client can set the login password (**Note: The password for the CMS client password, non-DVR login password**).



Picture 5.3 CMS login interface

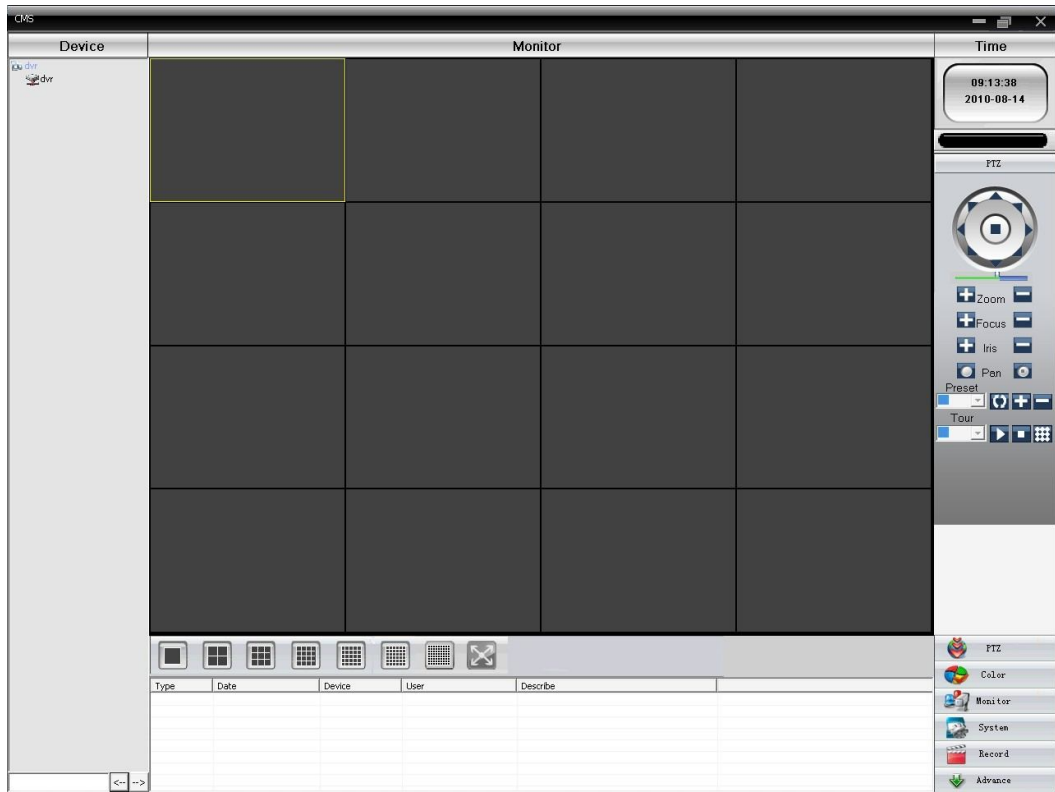

After the enter into CMS interface, shown in Picture 5.4:



Picture 5.4 CMS control interface

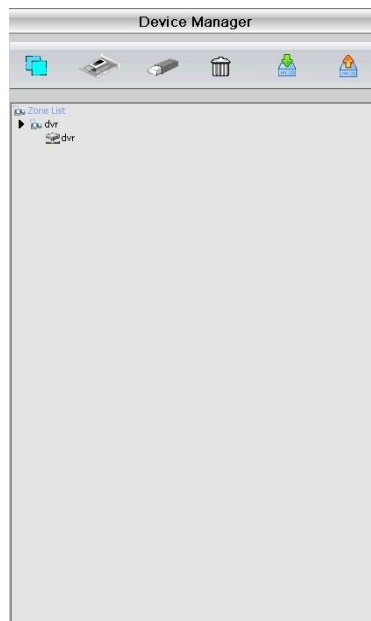

Click the right corner of “System” settings, switch to the control of management options as below:

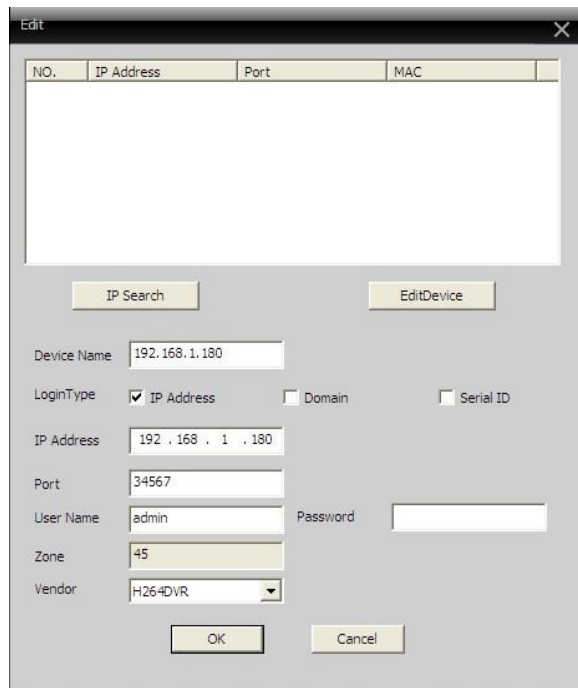

First click  to add a domain, region name are free to take, after determining the list of selected regional areas to create a domain name, select  add device as shown below:



As the follow prompts to input the DVR device requires information, confirmed and adding successful, repeat the above operation, can be added to multiple DVR equipment, management and monitoring operations.

If you want to modify the equipment which have added before,selected the modify the DVR at first,then click the  icon to modify the parameters,but also can delete the DVR which added on the regional list already for  deletion.

After completed add DVR these steps,click the label of the right corner for real-time monitoring, switch to multi-monitor screen interface, double-click the top left column of the DVR channel device can carry out real-time monitoring.

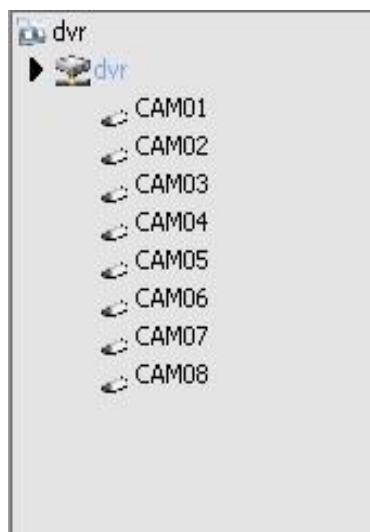

- This manual describes only the basic operations, the detailed operation please refer to the electronic manual CD-ROM;

- Equipment updated in real time,if upgraded without notice;
- If have doubt or dispute for product description,all as to the ultimate interpretation of the company;
- The manual for the number of products that do reference the specific operation of each product is not an exhaustive encounter difficult problems please contact the company customer service department.

6. FAQ and Maintenance

6.1 FAQ

If the problems are not listed, please contact the local service or call the HQ service. We are willing to offer the service.

1、 **The DVR can not boot up normally.**

Possible reasons are as followed:

- 1 The power supply is not correct.
- 2 Switch power supply line is not in good connection.
- 3 Switch power supply is damaged.
- 4 The program updating is wrong.
- 5 The hard disk is damaged or the hard disk lines are broken.
- 6 The front panel is damaged.
- 7 The main board of the DVR is damaged.

2、 **The DVR reboots automatically or stops working after boot up a few minutes.**

Possible reasons are as followed:

- 1 The input voltage is not stable or too low.
- 2 The hard disk is damaged or the hard disk lines are broken.
- 3 The power of the switch power supply is low.
- 4 Frontal video signal is not stable.
- 5 Bad heat radiator or too much dust or bad running circumstance for the DVR.
- 6 The hardware of the DVR is damaged.

3、 **System can not detect hard disk.**

Possible reasons are as followed:

- 1 The hard disk power supply line is not connected.

- 2 The cables of the hard disk are damaged.
- 3 The hard disk is damaged.
- 4 The SATA port of main board is damaged.

4、 **There are no video outputs in single channel, multiple channels and all channels.**

Possible reasons are as followed:

- 1 The program is not matched. Please update the program.
- 2 The image brightness is all 0. Please resume the default setup.
- 3 There is no video input signal or the signal is too weak.
- 4 The channel protection or the screen protection is set.
- 5 The hardware of the DVR is damaged.

5、 **Real-time image problems such as the image color or the brightness distortion.**

Possible reasons are as followed:

- 1 When using the BNC output, the option between the N mode or PAL mode is wrong and the image becomes black and white.
- 2 The DVR is not matched the monitor impedance.
- 3 The video transmission distance is too far or the loss of the video transmission line is too large.
- 4 The color and brightness setting of the DVR is wrong.

6、 **I can not find the video files in local playback mode.**

Possible reasons are as followed:

- 1 The data line of the hard disk is damaged.
- 2 The hard disk is damaged.
- 3 Update the different program with the origin program files.
- 4 The video files to look up are covered.
- 5 The recording is not on.

7、 **The local video is not clear.**

Possible reasons are as followed:

- 1 The image quality is too bad.
- 2 The reading program is wrong. Reboot up the DVR.
- 3 The data line of the hard disk is damaged.
- 4 The hard disk is damaged.

5 The hardware of the DVR is damaged.

8、 There is no audio signal in the surveillance window.

Possible reasons are as followed:

- 1 It is not an active tone arm.
- 2 It is not an active sound box.
- 3 The audio lines are damaged.
- 4 The hardware of the DVR is damaged.

9、 There is audio signal in the surveillance window but no audio signal in the playback state.

Possible reasons are as followed:

- 1 Setting issues: the audio option is not chosen.
- 2 The according channel is not connected with the video.

10、 The time is wrong.

Possible reasons are as followed:

- 1 Setting is wrong..
- 2 The battery is in bad connection or the voltage is too low.
- 3 The oscillation is damaged.

11、 The DVR can not control the PTZ.

Possible reasons are as followed:

- 1 There is something wrong with the frontal PTZ.
- 2 The setting, connection or the installation of the PTZ decoder is not correct.
- 3 The connections are not correct.
- 4 The PTZ setting of the DVR is not correct.
- 5 The protocols of the PTZ decoder and the DVR are not matched.
- 6 The address of the PTZ decoder and the DVR are not matched.
- 7 When multiple decoders are connected, the far port of the PTZ decoder line A(B) must connect a 120Ω resistance to reduce the reflection otherwise the PTZ control is not stable.
- 8 The distance is too far.

12、 The motion detect is not working,

Possible reasons are as followed:

- 1 The time range set is not correct.

- 2 The motion detect area set is not correct.
- 3 The sensitivity is too low.
- 4 Limited by some hardware edition.

13、 I can not login via web.

Possible reasons are as followed:

- 1 The system is windows 98 or windows me. We recommend updating to windows 2000sp4 or higher edition or installing the software for low edition.
- 2 ActiveX is hold back.
- 3 The edition is not exceeded dx8.1. Update the display card driver.
- 4 Network connection failure.
- 5 Network setting issues.
- 6 Invalid password or user name.
- 7 The user edition is not matched the DVR program edition.

14、 The image is not clear or there is no image in network preview state or video file playback state.

Possible reasons are as followed:

- 1 Network is not stable.
- 2 The user machine is resource limited.
- 3 Choose the play-in-team mode in the network setup of DVR.
- 4 The region shelter or channel protection is set.
- 5 The user has no surveillance purview.
- 6 The real-time image of the hard disk recording machine itself is not clear.

15、 Network connection is not stable.

Possible reasons are as followed:

- 1 Network is not stable.
- 2 IP address is conflicted.
- 3 MAC address is conflicted.
- 4 The network card of the computer or the hard disk recording machine is bad.

16、 There is something wrong with the USB backup or writing a CD.

Possible reasons are as followed:

- 1 The rewritable machine and the hard disk are shared the same data lines.

- 2 The data is too much. Please stop recording and backup.
- 3 The data exceeds the backup storage.
- 4 The backup equipment is not compatible.
- 5 The backup equipment is damaged.

17、 The keyboard can not control the DVR.

Possible reasons are as followed:

- 1 The serial port of the DVR is not set correctly.
- 2 The address is not correct.
- 3 When multiple transformers are connected, the power supply is not large enough. Please give each transformer individual power supply.
- 4 The distance is too far.

18、 Alarm can not be recessional.

Possible reasons are as followed:

- 1 The setting of the alarm is not correct.
- 2 The alarm output is turned on manually.
- 3 The input machine is damaged or the connections are not correct.
- 4 There are some problems for specific program edition, Please update the program.

19、 Alarm is not working.

Possible reasons are as followed:

- 1 The setting of the alarm is not correct.
- 2 The connection of the alarm is not correct.
- 3 The alarm input signal is not correct.
- 4 A alarm is connected with two loops synchronously.

20、 The remote controller is not working,

Possible reasons are as followed:

- 1 The remote control address is not correct.
- 2 The remote control distance is too far or the angle is too large.
- 3 The battery is used up.
- 4 The remote controller or the front panel of the recording machine is damaged.

21、 The storage time is not enough.

Possible reasons are as followed:

- 1 Front vidicon quality is bad. The lens is too dirty. The vidicon is in backlighting installation.
- 2 The hard disk capability is not enough.
- 3 The hard disk is damaged.

22、 The downloading files can not play.

Possible reasons are as followed:

- 1 There is no media player.
- 2 There is no DX8.1 software or higher edition.
- 3 There is no DivX503Bundle.exe file to play AVI video files.
- 4 The DivX503Bundle.exe and ffdshow-2004 1012 .exe files must be installed in the windows xp system.

23、 I can not remember the advanced code or network code in the local menu operation.

Please contact the local service or call the HQ service. We will offer the service according the machine type and the program edition.

6.2 Maintenance

- 1 Please brush printed circuit boards, connectors, fans, machine box and so on regularly.
- 2 Please keep the grounding well done to prevent the video or audio signal interfered and the DVR from static or inductive electricity.
- 3 Do not pull out the video signal line or RS-232 port or RS-485 port with the power on.
- 4 Do not use the TV in the local video output port(VOOUT) of DVR. It will damage the video output circuit easily.
- 5 Do not turn off the switch directly. Please use the turn-off function in the menu or press the turn-off button in the panel (3 seconds or longer) to protect the hard disk.
- 6 Please keep the DVR away from heat resource.
- 7 Please keep the DVR ventilated for better heat radiator.

Please check the system and maintain regularly.

Appendix 1. Remote controller operation

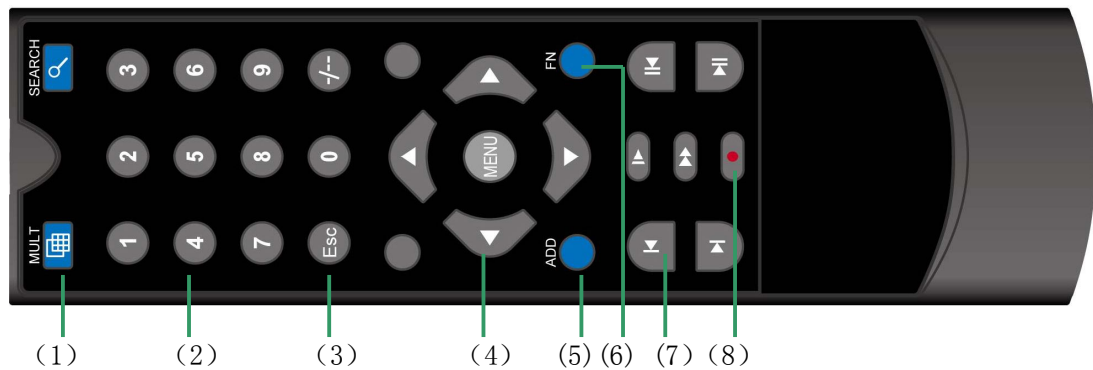

Serial number	Name	Function
1	Multi-window button	Same function as Multi-window button in the front panel
2	Numeric button	Code input/number input/channel switch
3	【Esc】	Same function as 【Esc】 button in the front panel
4	Direction button	Same function as direction button in the front panel
5	ADD	Input the number of DVR to control it
6	FN	Assistant function
7	Record control	Control the record
8	Record mode	Same function as “Record mode”

Appendix 2. Mouse operation

***Take right hand as an example**

The mouse in USB connection is supportive.

Operation	Function
Double left click	Double click one item in the file list to playback the video
	Double click the playback video to zoom in or out the screen
Double left click	Double click the channel to make it full screen display
	double click again to resume the multi-window display

Left click	Choose the according function in the menu
Right click	Pop desktop shortcut menu in preview state
	Current shortcut menu in the menu
Press middle button	Add or subtract number in the number setting
	Switch the items in the combo box
	Page up or down in the list
Move mouse	Choose the widget or move the item in the widget
Drag mouse	Set the motion detect area
	Set the cover area

Appendix 3. Hard Disk capability calculation

Make sure the hard disk installed to install the DVR for the first time. Pay attention to the IDE hard disk lines connection.

1、 Hard disk capability

There is no limit for recording machine. We recommend 120G~250G size to keep better stability.

2、 Overall capability option

The hard disk capability formula is:

Overall capability (M) = channel number * time (hour) * capability in an hour (M/hour)

The recording time formula is:

$$\text{Recording time (hour)} = \frac{\text{overall capability (M)}}{\text{Capability in an hour (M/hour)} * \text{channel number}}$$

The DVR introduces the MPEG4/H.264 compression technology. Its dynamic range is very large so the hard disk capability calculation is based on the estimation values of each channel creating files in an hour.

Example:

The video files in each channel need 200M capability in an hour. For 4 channels and one month(24hours a day) the needed hard disk capability is: 4channel*30days*24hours*200M/hour=576G. So it will need one 500G hard disks.

Appendix 4. Technique parameters

	Type	4 Channel	8 Channel	16 Channel
System	Main processor	Industry level embedded microprocessor		
	Operation system	Embedded LINUX operation system		
	System resource	synchronous multi-channel recording, synchronous multi-channel sub-code stream, synchronous multi-channel playback, synchronous network operation		
Interface	Operation interface	16 bit true color graphical menu interface, mouse operation supportive		

	display	1/4 image display	1/4/8/9 image display	1/4/8/9/16 image display	
Video	Video standard	PAL (625string, 50 field/s)			
	Surveillance image quality	PAL, D1(704×576)			
	Playback image quality	PAL,D1(704*576)/HD1(704*288)/CIF(352×288)/ QCIF(176×144)			
	Image compression	H.264 mp			
	Image control	6 types for optional			
	Recording speed(CIF)	PAL, 100fps overall	PAL, 200fps overall	PAL,400fps overall	
	Image motion detect	396(22×18) detection areas, multiple sensitivity			
Audio	Audio compression	G.711A			
	Talk-back	NO			
Recording And Playback	Recording mode	manual >alarm>motion detect>timing			
	Local playback	1channel playback, multi-channels playback at the same time (basic model no such function)			
	Recording look-up mode	Time searching, calendar searching, affair searching, channel searching, information searching			
Storage And Backup	Hard disk capability for each channel	Audio: 28.8Mbytes/hour Video:25~450Mbytes/hour			
	Recording storage	Hard disk, network			
	Backup mode	Network, USB device			
Port	Video input	4channel BNC	8channel BNC	16channel BNC	
	Video output	1channel BNC, 1channel VGA output (with VGA interface standard)			

	Circulation output	non		
	Matrix output	non		
	Audio input	4channel RCA	8channel RCA	16channel RCA
	Audio output	1channel RCA		
	Alarm input	4channel	4channel	8channel
	Alarm output	1channel		
	Network port	RJ45 10M/100M adoptive Ethernet network port		
	PTZ control port	1 RS485		
	USB port	2 USB ports (synchronous use front and rear panel forbidden)		
	Hard disk port	1 SATA port	1 SATA & 2 SATA port	2 SATA port
Other	Power supply	DC 12V external power adapter		
	Power consume (without hard disk)	<10W		<15W
	Working temperature	0°C~+55°C		
	Working humidity	10%—90%		
	Air pressure	86kpa—106kpa		
	Size	Please refer to the real object		
	Weight	Please refer to the real object		
	Installation	Frame installation, platform installation		